



Automatic Satellite System

KD2000 Stationary KD3000 In-Motion

Installation and Operating Instructions



Digital TV Solutions for Mobile Markets

11200 Hampshire Avenue South, Bloomington, MN 55438-2453
Phone: (952) 922-6889 Fax: (952) 922-8424

www.kingcontrols.com

IMPORTANT!

The TV market is expanding and changing. The information in this manual was accurate at the time of printing. If your King-Dome does not operate as outlined in this manual please call King Controls at (952) 922-6889 or visit our website at www.kingcontrols.com. King Controls is not responsible for changes outside of its control.

The King-Dome is factory pre-set for DIRECTV® standard digital programming broadcast from the 101° W satellite. If you also receive your local channels from DIRECTV's 119 satellite or if you subscribe to DISH® or Bell TV programming, **YOU MUST CONFIGURE THE ANTENNA** to work with your satellite service. Doing this will allow the King-Dome to lock on the correct satellites to receive your programming and also enable automatic satellite switching via the receiver's remote control for multi-satellite service.

Antenna configuration is a one time procedure that **MUST BE COMPLETED** before using your King-Dome antenna. Configuration may be done with the supplied wall mount controller, or the #1844 Keypad (dealer tool). See the antenna configuration section in this manual for specific instructions.

The King-Dome will not receive HD channels broadcast from DIRECTV's Ka band satellites at 99° and 103°.

Please read this entire manual before beginning the installation.

TABLE OF CONTENTS

Section	Contents	Page
1.	INTRODUCTION	2-3
2.	DEFINITION OF TERMS	3
3.	INSTALLATION	4-12
4.	ANTENNA CONFIGURATION	13-25
5.	OPERATION	26-27
6.	SECOND RECEIVER OPERATION FOR DISH	28-29
7.	TROUBLESHOOTING	30
8.	MAINTENANCE	31
9.	LIMITED WARRANTY	32

Section 1 INTRODUCTION

The King-Dome 2000 and 3000 Satellite Systems include (2) main components (**Fig. 1**).

- | | |
|---------------------|---|
| Dome (Antenna) Unit | Located on the roof of the vehicle. The satellite dish and electronics are covered by a protective dome that keeps operational components free from the elements. |
| Controller | Located in the vehicle. Activates the search mode and provides limited diagnostic functions using the status light. |

NOTE: A TV, satellite receiver, and program subscription are also required for satellite TV viewing (sold separately).

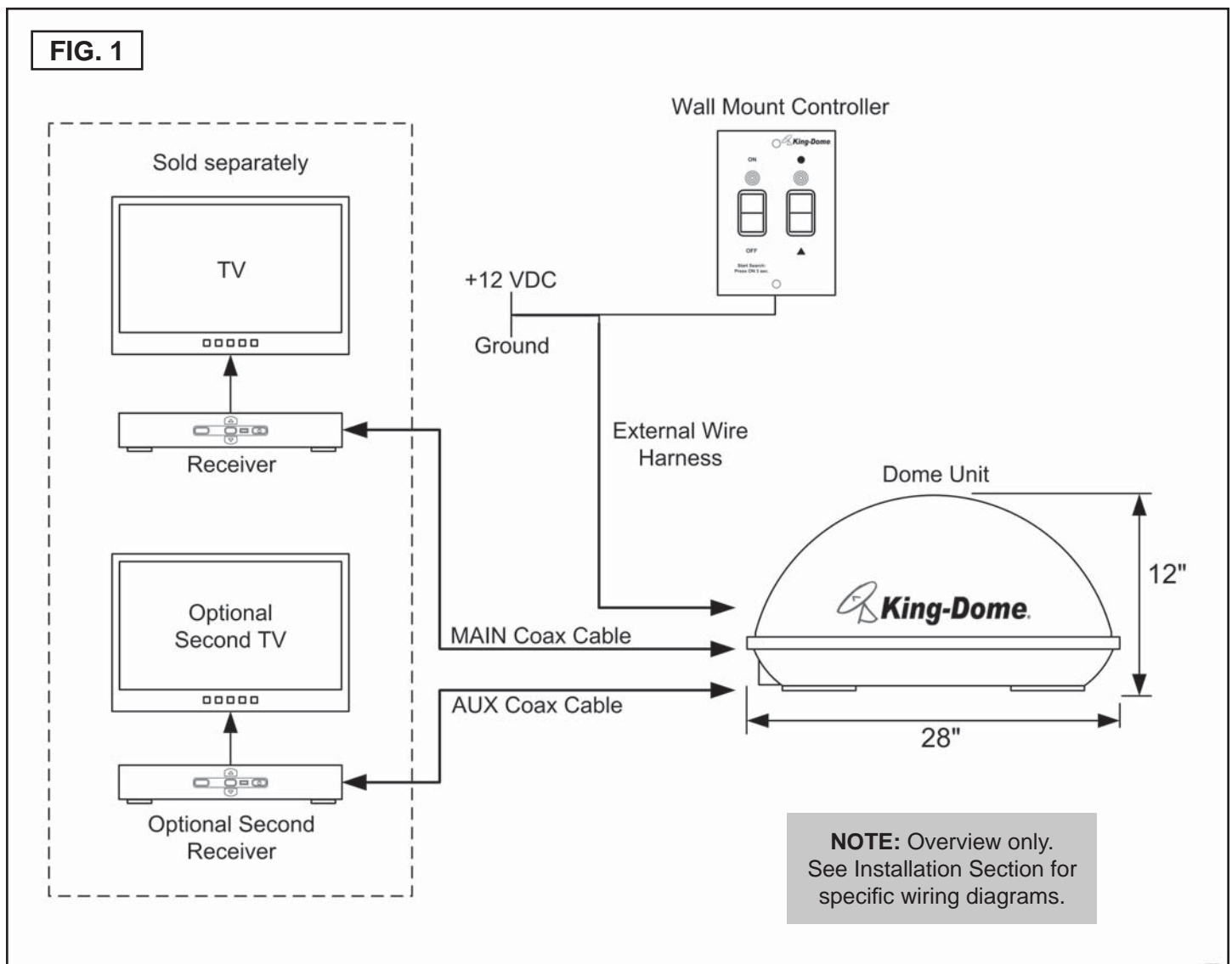

IMPORTANT!

The antenna unit requires a “direct line of sight” to the satellite for signal reception. Any tall objects such as poles, trees, buildings, mountains, etc. can all block the signal from reaching the dish.

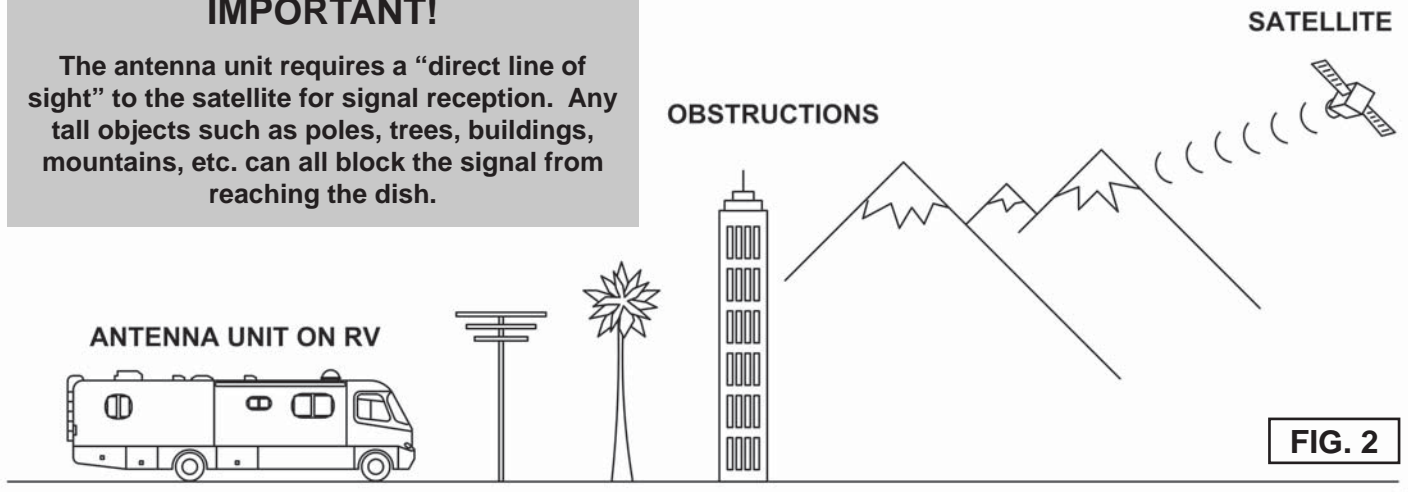

Section 2 DEFINITION OF TERMS

SIGNAL STRENGTH: Intensity of signal received from the satellite.

FIG. 3

AZIMUTH:

Circular rotation around the vehicle. Using the clock as a reference, the front of the vehicle is 12:00 and the rear is 6:00.

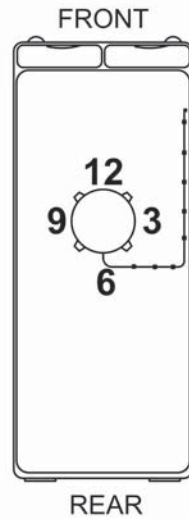

FRONT OF VEHICLE = 12:00



REAR OF VEHICLE = 6:00

FIG. 4

ELEVATION: Angle in degrees measured from a level plane.

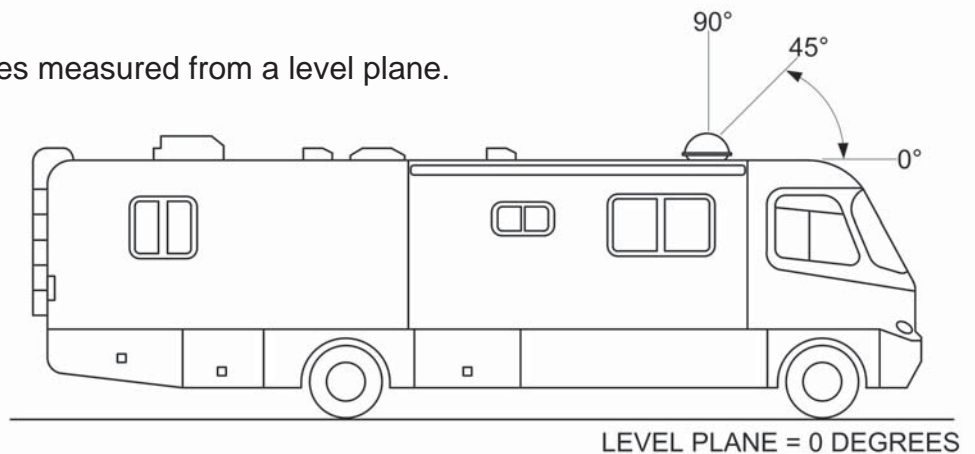

Section 3 INSTALLATION

TOOLS AND MATERIALS REQUIRED

- drill and drill bit set
- tape measure
- 7/16" open end wrench (coax connections)
- adhesive sealant (compatible with roof material)
- appropriate fasteners to install all components and wiring
- 5/32" allen wrench, channel lock or pliers (to remove shipping bolts)
- wire cutter (to remove shipping tie strap)
- Optional: #1844 King Controls Keypad



KIT CONTENTS

1. Unpack and identify all components (**Fig. 5**).

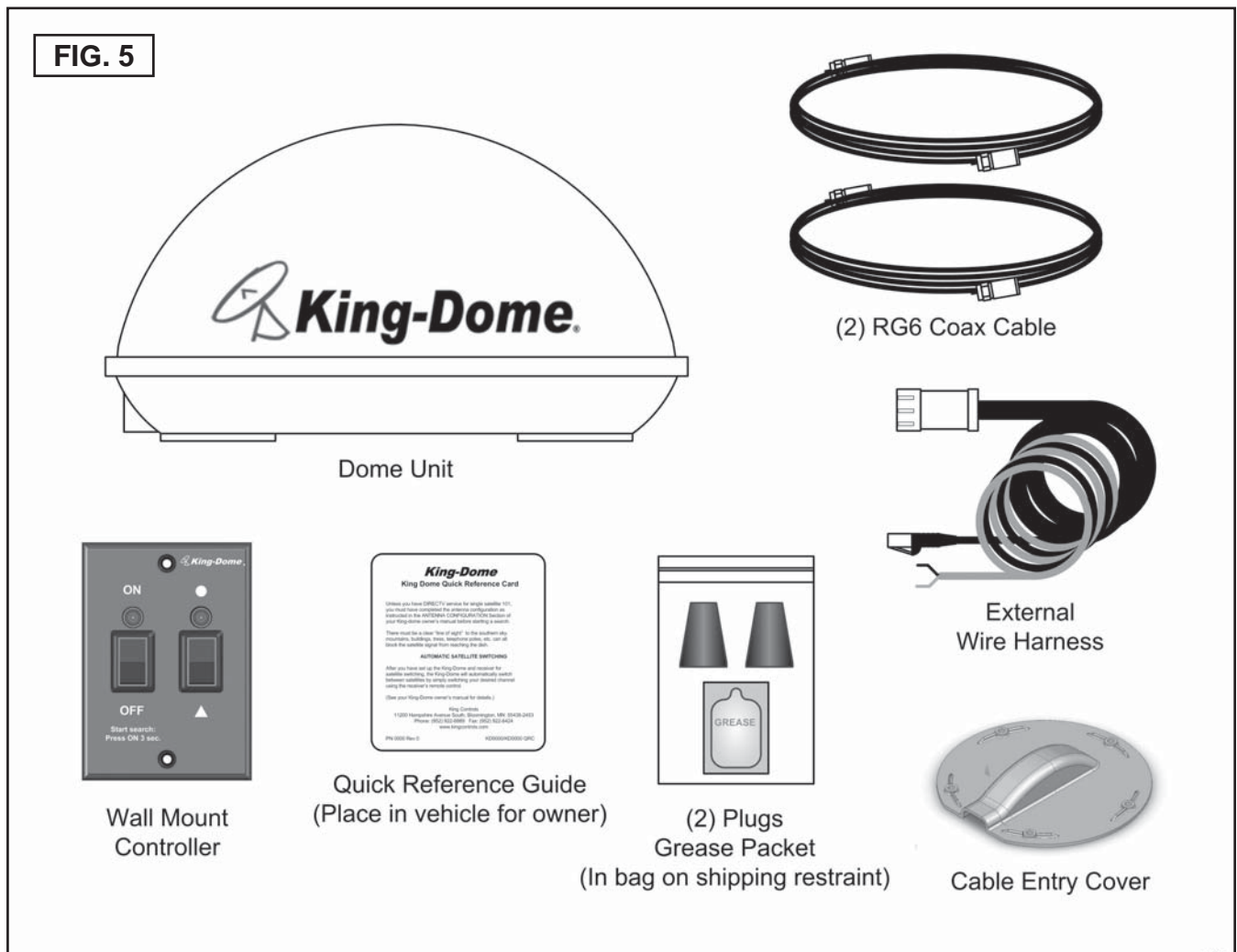

IMPORTANT! The tie strap and spacer, and the shipping bolts and washers must be removed from the bottom of the dome unit prior to installation. **DO NOT REMOVE THE DOME COVER TO REMOVE THESE SHIPPING RESTRAINTS.**

YOU MUST PLUG THE SHIPPING BOLT HOLES WITH THE SUPPLIED PLUGS (ATTACHED TO TIE STRAP SHIPPING RESTRAINT).

2. Remove and discard the tie strap and spacer (**KEEP RUBBER PLUGS AND GREASE PACKET**), and the (2) bolts and (2) washers that pass through the bottom of the base (**Fig. 6**).
3. Insert provided plugs into holes that were occupied by the shipping bolts. Inserted plugs should be flush with base (**Fig. 6**).

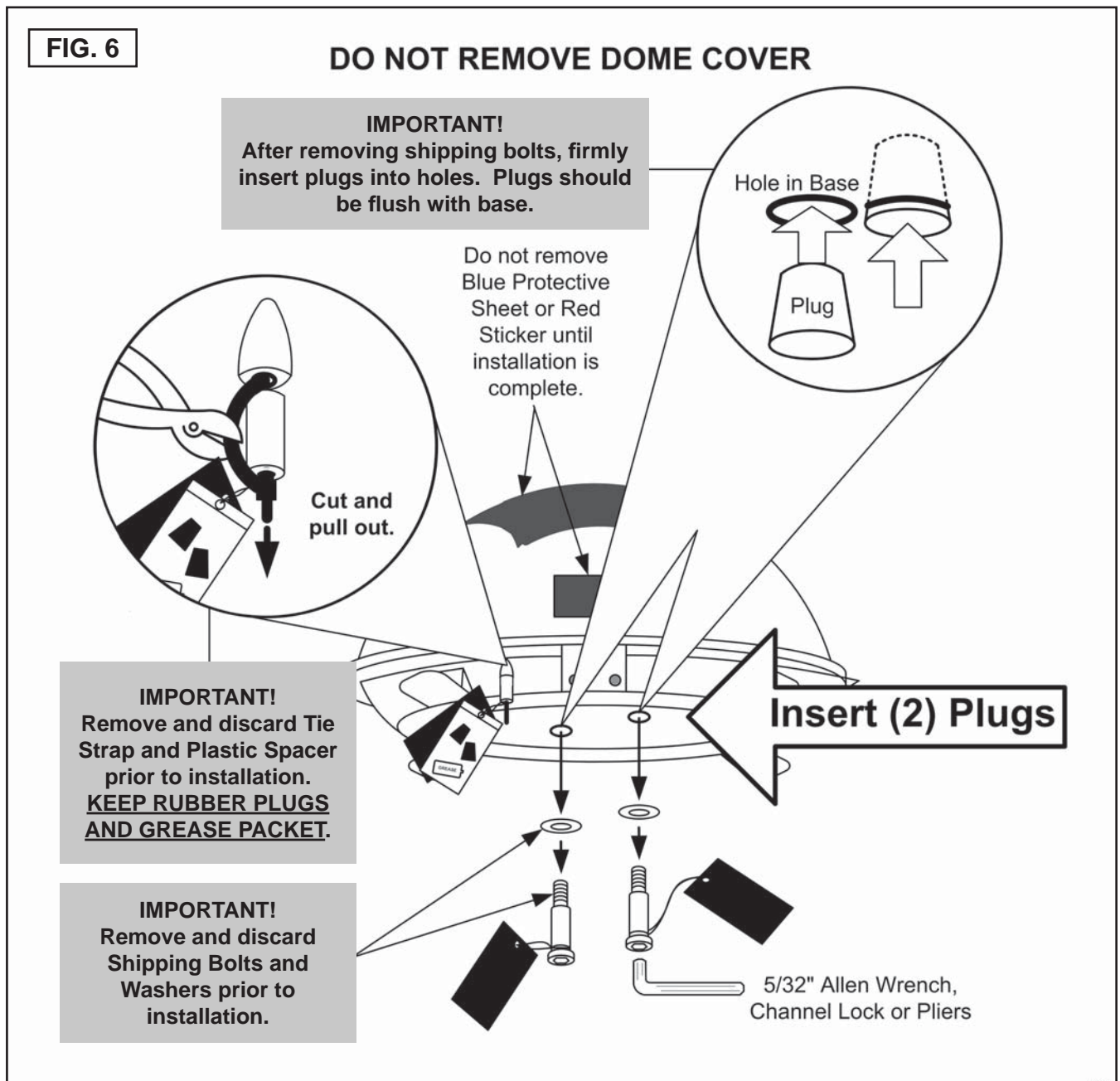

NOTE: Many RVs are pre-wired for satellite with RG6 coaxial cable. Contact the manufacturer of your RV or your local dealer to verify where the coax cable for satellite pre-wire is located.

If pre-wired, run the existing pre-wiring from the pre-wire location to the dome unit. When choosing the dome unit location, make sure the pre-wiring will reach the dome unit.

Make all connections, properly route and fasten wiring to roof, and completely waterproof entry hole with the cable entry cover as shown in this section. You may still run the second coax to the rear of the vehicle for an optional second receiver.

DOME LOCATION

4. Select an area on the roof for the dome unit and the location where the wiring will enter the vehicle through the roof to the satellite receiver, controller and 12 volt power source inside, using the following criteria:
 - a) A shorter distance between the dome unit and the satellite receiver is most desirable.
 - b) The dome unit requires a 28 inch diameter mounting area.
 - c) The dome unit should be mounted on the centerline of the vehicle.
 - d) There must be no “line of sight” obstructions. Air conditioning units, other antennas, and storage areas that are too close to the dome unit may obstruct the satellite signal (**Fig. 7**).

FIG. 7

HEIGHT OF OBSTRUCTION	APPROXIMATE MINIMUM DISTANCE TO DOME EDGE
10"	8"
11"	10"
12"	12"
13"	14"
14"	16"
15"	18"
16"	20"

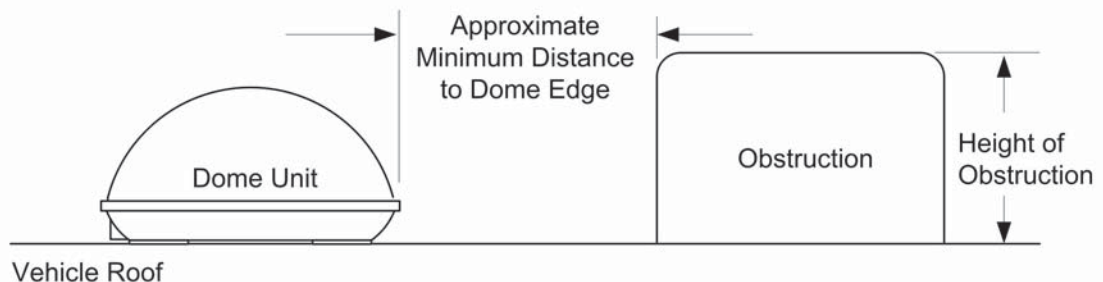

DOME INSTALLATION

IMPORTANT! Make sure shipping restraints are removed from bottom of dome unit and plugs are inserted in holes (Fig. 6, Page 5).

Cable connections must **ALWAYS** be positioned facing the rear of vehicle.

5. Place dome unit on installation location chosen using the criteria discussed in the previous section. Shipping restraints must be removed, plugs must be inserted in holes (**Fig. 6, Page 5**), and cable connections must be positioned facing rear of vehicle.
6. Position the dome unit so that both feet on each side of the vehicle are equal distances from the roof edge. This should be checked by measuring the distance from each foot to the roof edge. Confirm that these measurements are equal (**Fig. 8**).

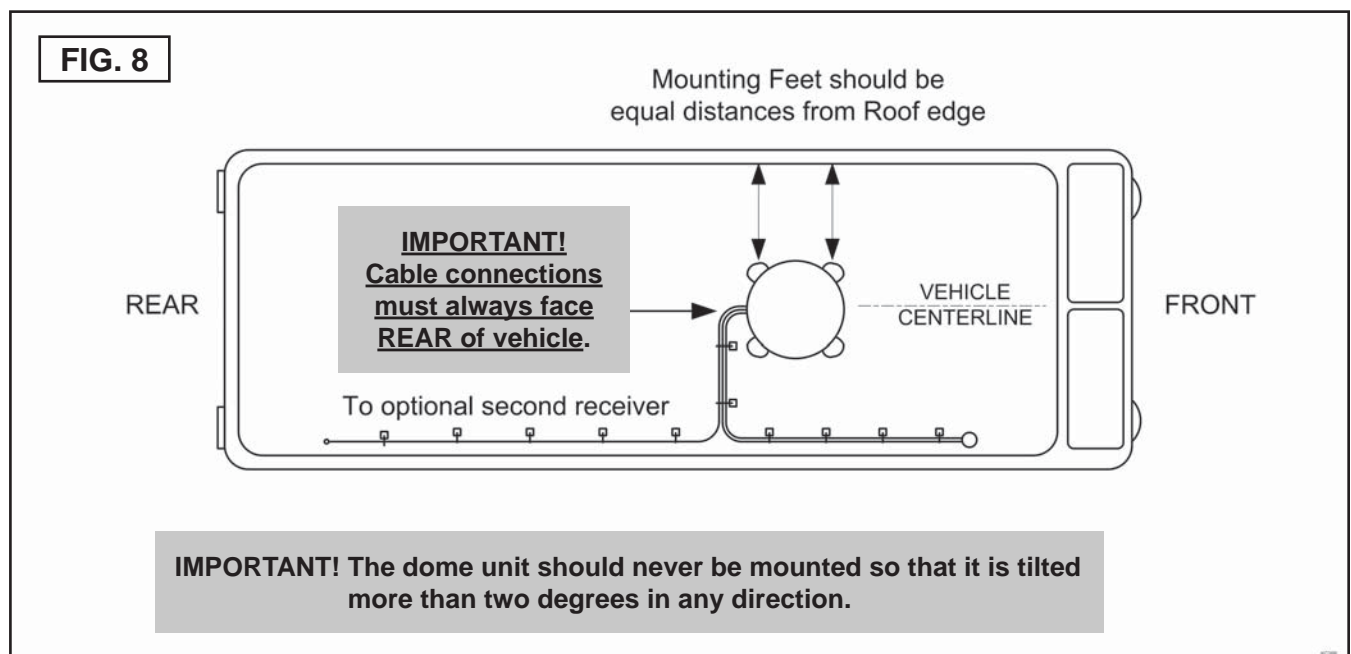

NOTE: The installer is responsible for determining the most appropriate fastener to secure the dome unit to the roof. Depending on the roof material, fasteners such as lag screws, sheet metal screws, toggle bolts and T anchors may be used, and should always be used in combination with a roof compatible sealant.

IMPORTANT! The installer is responsible for weatherproofing all holes with sealant.

7. Mount the dome unit. Use the pre-drilled holes in the mounting feet as a guide to install the fasteners into the roof. Use additional fasteners whenever necessary.
8. Test that the dome unit is secure by pulling upward from each foot location.

EXTERNAL WIRING

9. Plug external wire harness into wiring port on back of dome unit and tighten connection until it clicks past the detent lock (**Fig. 9**).

NOTE: The King-Dome is wired for multiple receiver support. There are two coax ports on the back of the dome unit. The one labeled "MAIN" **MUST** be connected to the main receiver in vehicle. This is the receiver that will control automatic satellite switching if applicable. The one labeled "AUX" can be used for an additional receiver hook-up as well. You may wish to label the ends of the coax cables to avoid confusion when making connections.

IMPORTANT! You must fill the ends of all external coax cables with the supplied dielectric grease. Failure to do so will void product warranty.

10. Fill end of coax cable that will connect to the MAIN port on the dome unit with supplied dielectric grease. Connect this end of the coax cable to the MAIN port and tighten connection (**Fig. 9**).

If installing second receiver, fill end of coax cable that will connect to the AUX port on the dome unit with supplied dielectric grease. Connect this end of the coax cable to the AUX port and tighten connection.

DO NOT OVER TIGHTEN CONNECTIONS.

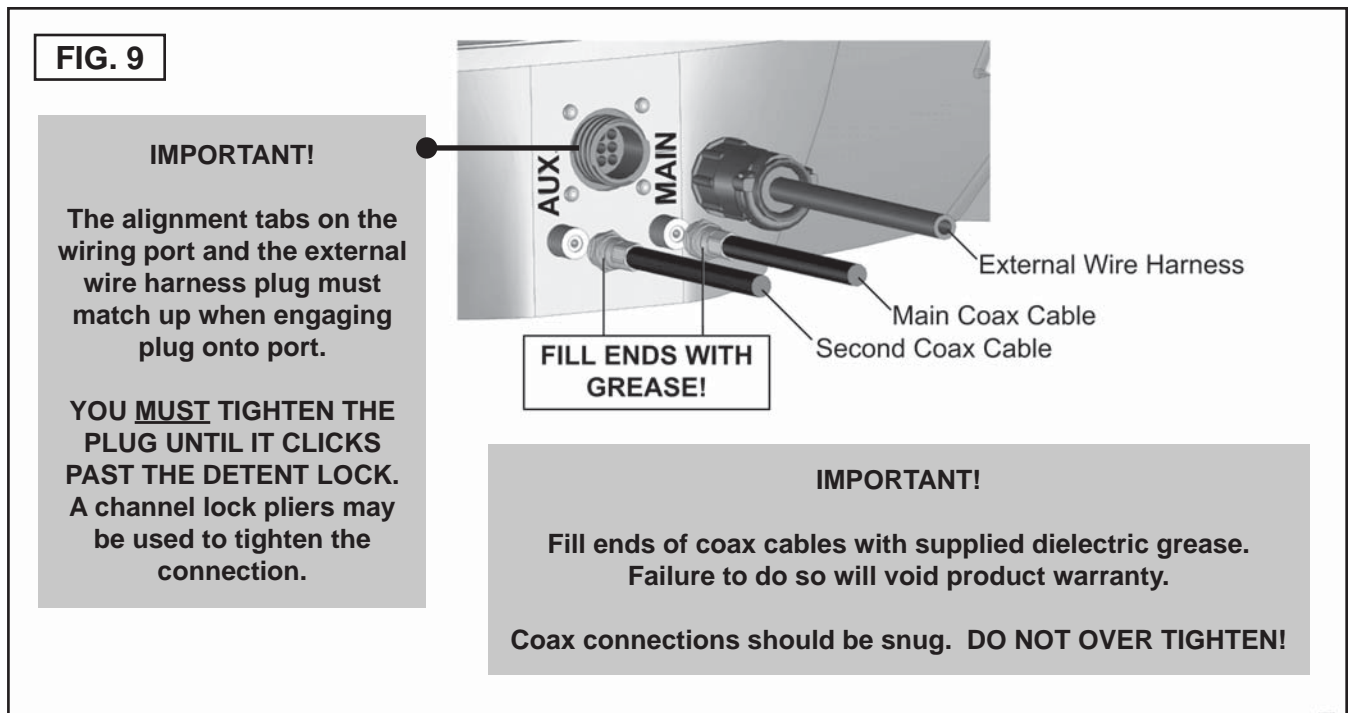

AVOID SHARP BENDS WHEN ROUTING COAX!

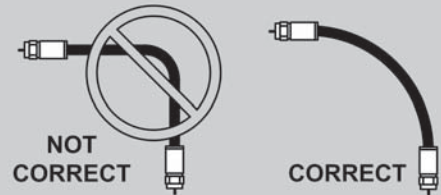

11. Run wires from the back of the dome unit to the roof edge, then along edge to location where wiring will be fed into the vehicle. If installing an optional second receiver, run second coax to location where it will enter the vehicle. Secure wiring to roof every 12-18 inches (**Fig. 10**).

IMPORTANT! Installer is responsible for determining proper roof compatible fasteners for cable entry cover.

Roof hole for wiring must be sealed so it is completely waterproof. Mounting holes, perimeter of cable entry cover and cable opening of cable entry cover must be sealed so they are completely waterproof. SEALANT MUST BE ROOF COMPATIBLE.

12. Drill 3/4" hole through the roof and into the cabinet where receiver is stored. Feed wiring down through hole. Seal opening with roof compatible sealant so that it is completely waterproof (inside and outside of the 3/4" hole). Repeat for second coax if present.
13. Fasten cable entry cover to roof. Seal mounting holes, perimeter of cover and cable opening so they are completely waterproof.

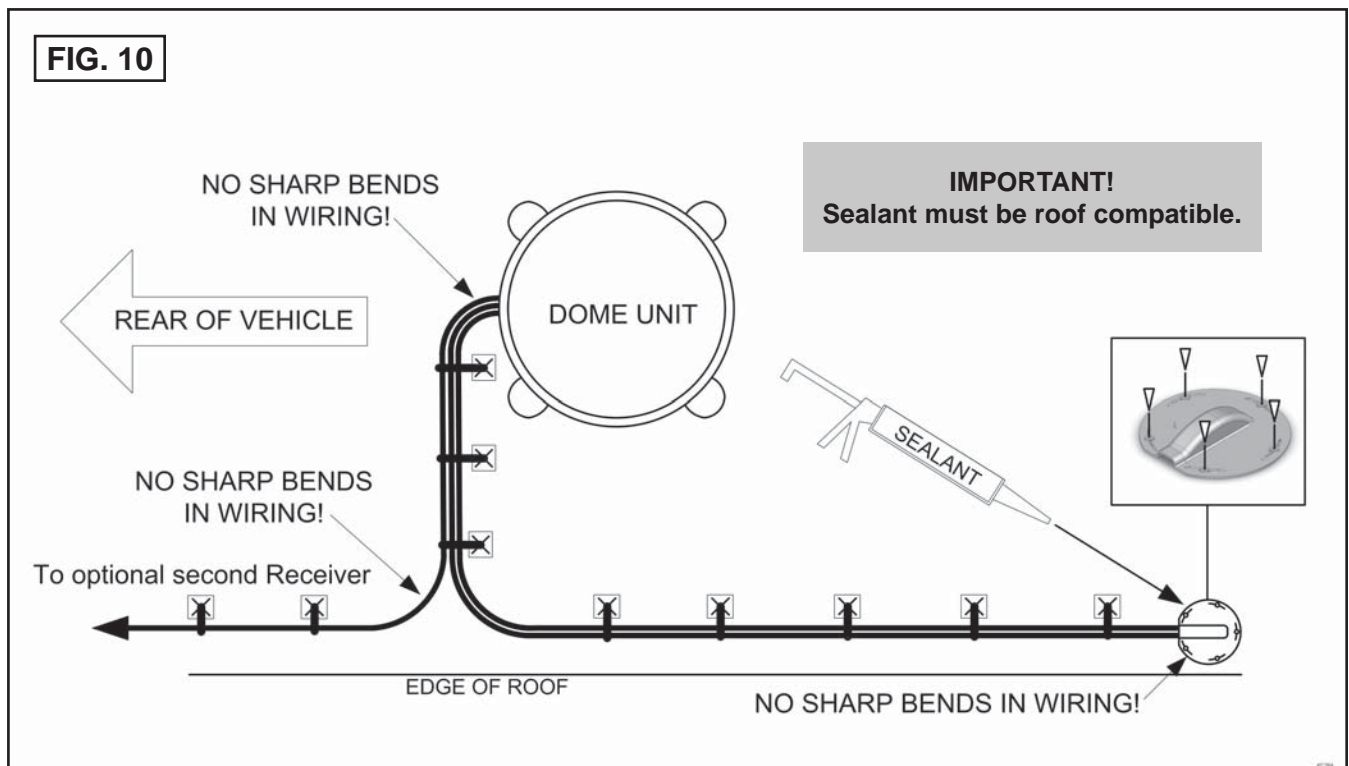

14. Remove blue protective sheet and red "position to rear" sticker from the dome unit.

INTERNAL WIRING

AVOID SHARP BENDS WHEN ROUTING COAX!

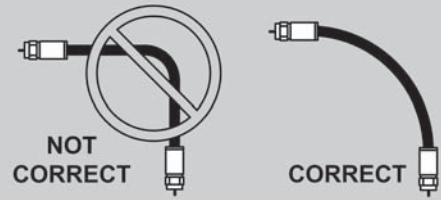

NOTE: Using multiple receivers is not recommended for multi-satellite services where automatic satellite switching is desired.

Components and wiring supplied with the KD2000/KD3000 are shown in black.
Existing components and wiring or those sold separately are shown in gray.

15. Choose your desired wiring configuration.

DIRECTV / Bell TV
(single satellite) Fig. 11, Page 11

DIRECTV / DISH / Bell TV
(2 or more satellites with auto switching) Fig. 12, Page 12

16. Inside the vehicle, make the connections as shown in the wiring diagrams, keeping in mind the following important points:

- a) The connection between the dome unit and the main satellite receiver must be a direct connection with no other devices in between.
- b) Power connection must be a non-shared circuit. Excessive current draw on the circuit will cause the unit to operate improperly. Power and ground connections must be made after all wiring is connected to the dome unit.
- c) If fusing the circuit, the fuse must be rated at 7.5 amps.
- d) HDTV receivers require HDMI or component video/audio cable connection to TV (sold separately).

17. When installation is complete, go to Section 4, **ANTENNA CONFIGURATION** on page 13.

FIG. 11

DIRECTV / Bell TV

King-Dome Models KD2000 & KD3000

Single satellite

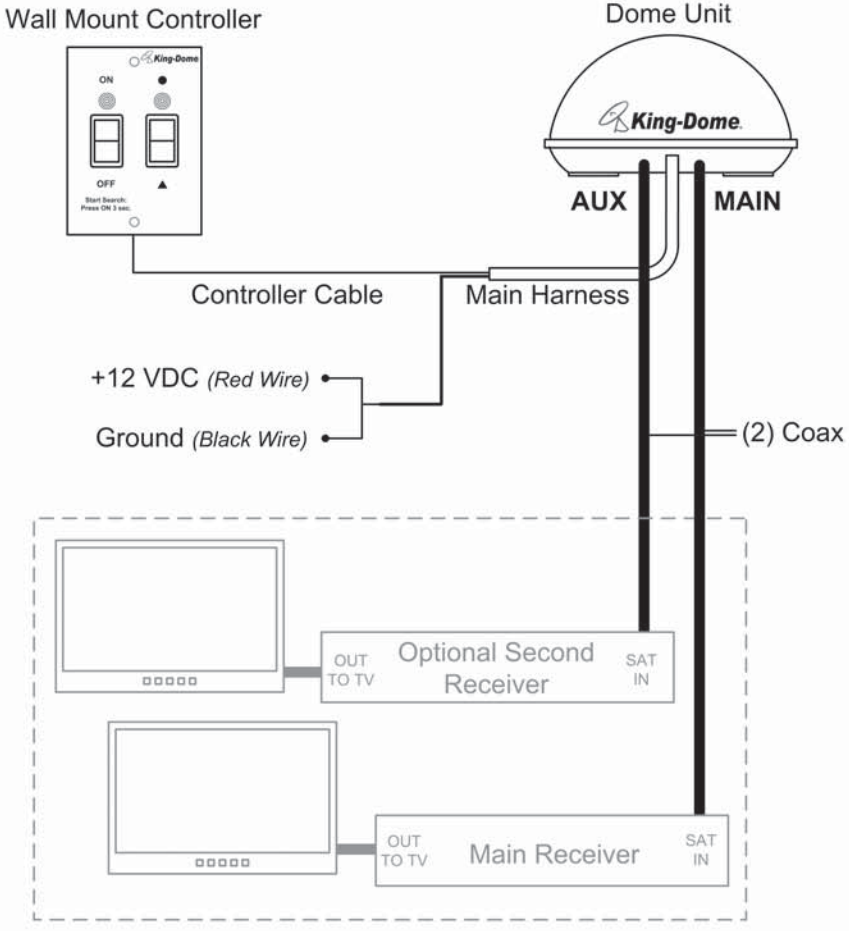

(OR)

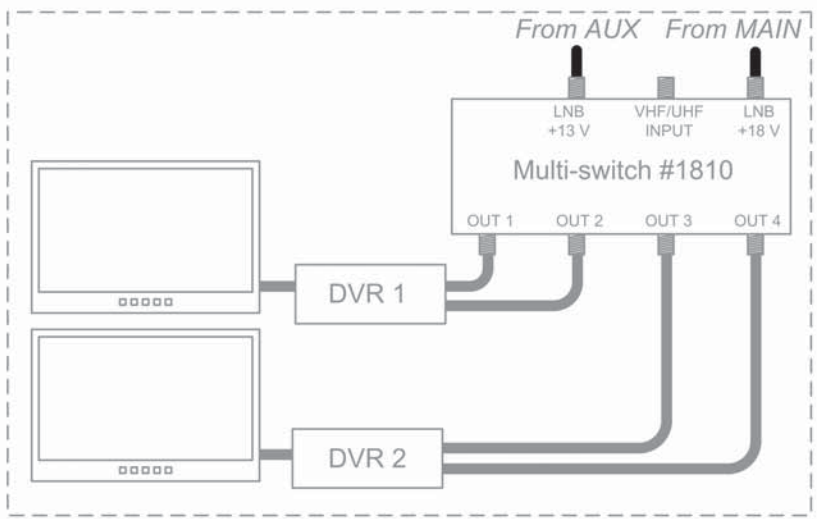

IMPORTANT!
Main coax cable must be connected to 18V input on multi-switch.

AVOID SHARP BENDS WHEN ROUTING COAX!

NOT CORRECT

CORRECT

FIG. 12

DIRECTV / DISH / Bell TV

King-Dome Models KD2000 & KD3000

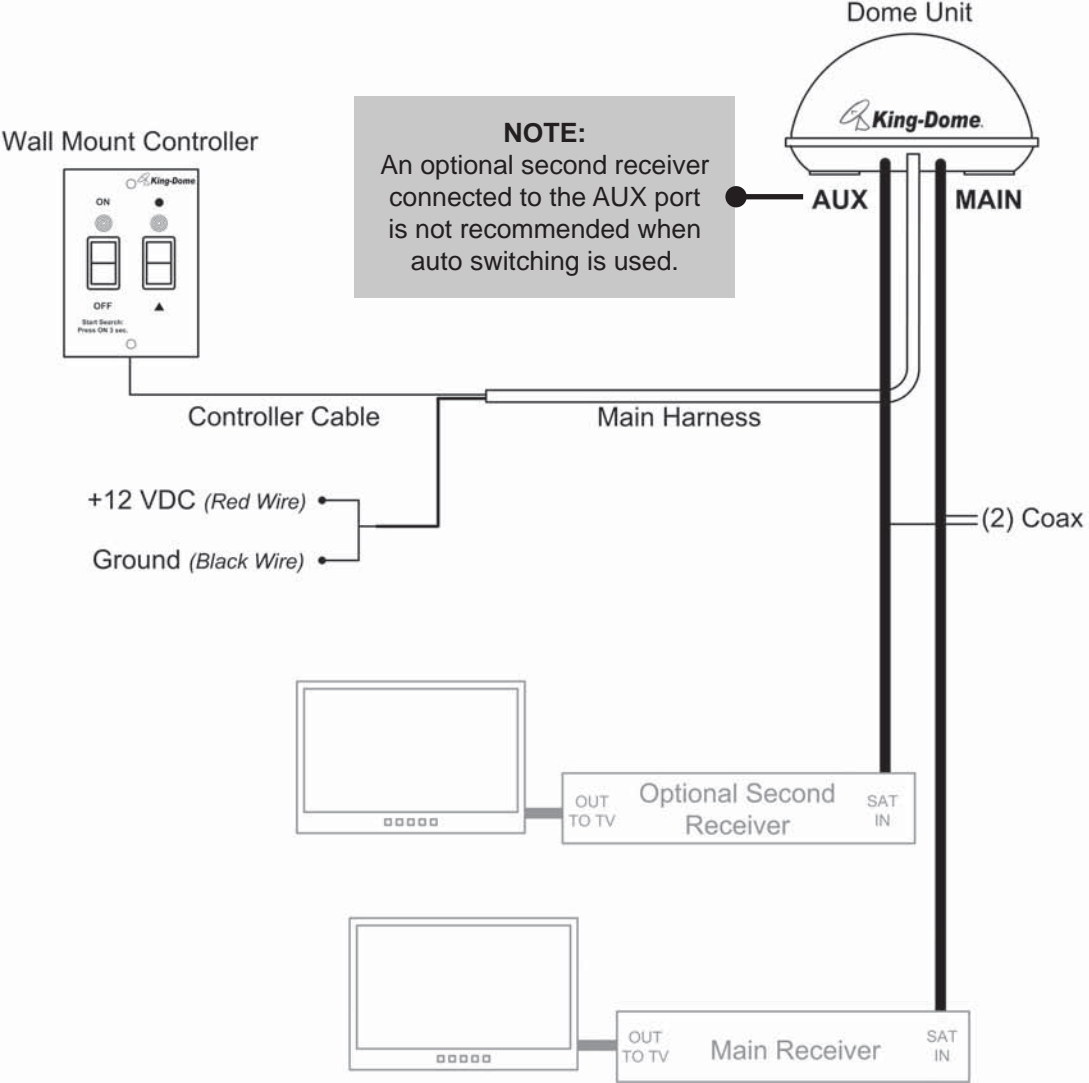

2 or more satellites with auto-switching



NOTE: Using multiple receivers is not recommended for multi-satellite services where automatic satellite switching is desired.

DISH SUBSCRIBERS: See section 6, SECOND RECEIVER OPERATION FOR DISH, if using an optional second receiver.

AVOID SHARP BENDS WHEN ROUTING COAX!

NOT CORRECT  CORRECT 

Section 4 ANTENNA CONFIGURATION

The King-Dome is factory pre-set for DIRECTV standard digital programming broadcast from the 101° W satellite.

If you also receive your local channels from DIRECTV's 119 satellite or if you subscribe to DISH or Bell TV programming, you must configure the antenna to work with your satellite service. Doing this will allow the King-Dome to lock on the correct satellites to receive your programming and also enable automatic satellite switching via the receiver's remote control for multi-satellite service.

Antenna configuration is a one time procedure that **MUST BE COMPLETED** before using your King-Dome antenna.

To configure your antenna, follow these steps:

1. ANTENNA CONFIGURATION

Configure the antenna for your service.

You can use either:

A) the supplied wall mount controller (page 14).

OR

B) #1844 Keypad (page 19).



2. DISH AND BELL TV CHECK SWITCH TEST

For all DISH and Bell TV services:

Configure your receiver for mobile use by running a check switch test (page 23).

ANTENNA CONFIGURATION USING WALL MOUNT CONTROLLER

NOTE: If you are using the keypad for programming, go to page 19.

On pages 15-18, find your service and follow the instructions in the box.

DIRECTV

DIRECTV SD (Factory Pre-set) Page 15
DIRECTV SD with Locals Page 15

DISH

DISH SD Page 16
DISH SD and HD Page 16
DISH SD and HD Alternate Page 17

Bell TV

Bell TV SD Page 18
Bell TV SD and HD Page 18

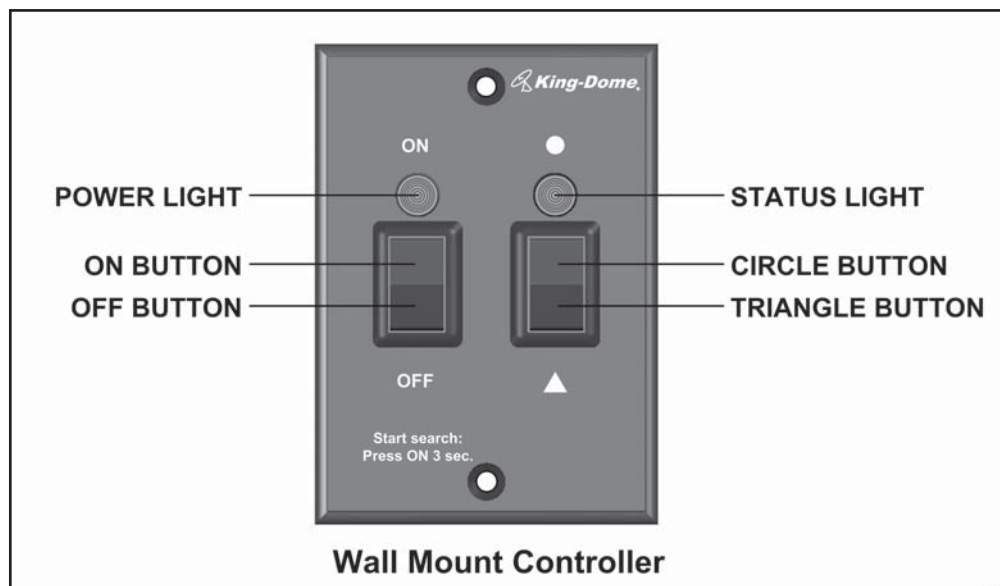

DIRECTV ANTENNA CONFIGURATION

DIRECTV SD (Satellite 101)

The King-Dome is factory pre-set for the DIRECTV 101 satellite. Unless the antenna has been configured for another option since leaving the factory, **PERFORM STEP 5 ONLY.**

1. On the King-Dome controller, press and release the ON button.
Wait for status light to flash orange, then **WAIT 4 MORE SECONDS.**
2. Press and release the ON button **16** times.
The status light starts rapidly flashing green and red.
3. Press and hold the ▲ button for 4 seconds. The status light will turn orange for 1 second, and then start flashing green or red.
4. Press OFF.

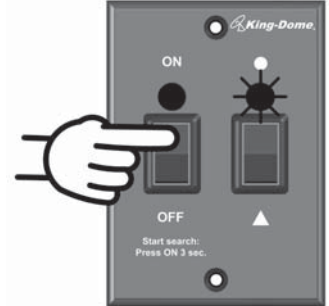

RECEIVER CONFIGURATION

5. If you have a newer receiver or current software, choose the following dish configuration settings (do this through the receiver's satellite set-up menu screens):

Dish Type: 01: 18" Round Switch Type: 02:Multiswitch
If you have an older receiver, choose round dish-1 satellite.

Configuration is complete. **Go to page 26.**

DIRECTV SD with Locals (Satellites 101, 119)

1. On the King-Dome controller, press and release the ON button.
Wait for status light to flash orange, then **WAIT 4 MORE SECONDS.**
2. Press and release the ON button **8** times.
The status light starts rapidly flashing green and red.
3. Press and hold the ● button for 4 seconds. The status light will turn orange for 1 second, and then start flashing green or red.
4. Press OFF.

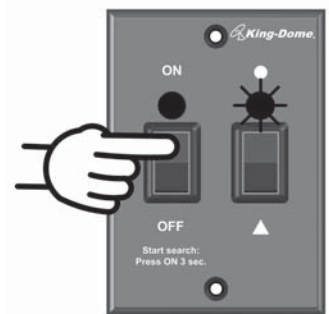

RECEIVER CONFIGURATION

5. If you have a newer receiver or current software, choose the following dish configuration settings (do this through the receiver's satellite set-up menu screens):

Dish Type: 02: 3-LNB (18 x 20") Switch Type: 02:Multiswitch
If you have an older receiver, choose oval dish-2 satellites.

Configuration is complete. **Go to page 26.**

DISH ANTENNA CONFIGURATION

DISH SD (satellites 110, 119)

1. On the King-Dome controller, press and release the ON button.
Wait for status light to flash orange, then **WAIT 4 MORE SECONDS.**
2. Press and release the ON button **12** times.
The status light starts rapidly flashing green and red.
3. Press and hold the ● button for 4 seconds.
The status light will turn orange for 1 second,
and then start flashing green or red.
4. Press OFF.
5. After you have successfully configured the antenna, you must configure your receiver for mobile use.

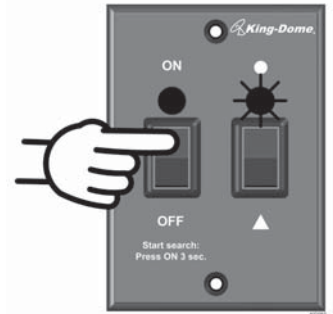

To configure your receiver for mobile use, **go to page 23 and run the check switch test.**

DISH SD and HD (satellites 110, 119, 129)

1. On the King-Dome controller, press and release the ON button.
Wait for status light to flash orange, then **WAIT 4 MORE SECONDS.**
2. Press and release the ON button **20** times.
The status light starts rapidly flashing green and red.
3. Press and hold the ● button for 4 seconds.
The status light will turn orange for 1 second,
and then start flashing green or red.
4. Press OFF.
5. After you have successfully configured the antenna, you must configure your receiver for mobile use.

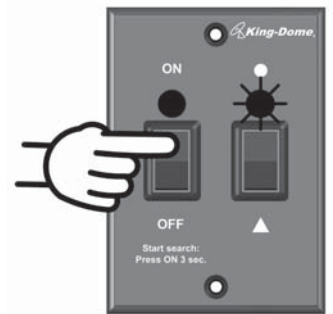

To configure your receiver for mobile use, **go to page 23 and run the check switch test.**

DISH SD and HD Alternate (satellites 61.5, 110, 119)

1. On the King-Dome controller, press and release the ON button.
Wait for status light to flash orange, then **WAIT 4 MORE SECONDS.**
2. Press and release the ON button **16** times.
The status light starts rapidly flashing green and red.
3. Press and hold the ● button for 4 seconds.
The status light will turn orange for 1 second,
and then start flashing green or red.
4. Press OFF.
5. After you have successfully configured the antenna, you must configure your receiver for mobile use.

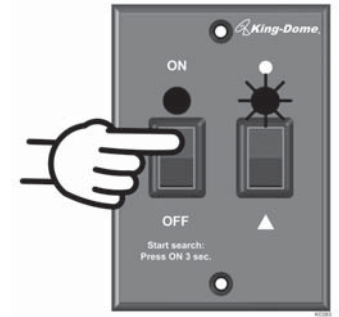

To configure your receiver for mobile use, **go to page 23 and run the check switch test.**

BELL TV ANTENNA CONFIGURATION

Bell TV SD (satellite 91)

1. On the King-Dome controller, press and release the ON button.
Wait for status light to flash orange, then **WAIT 4 MORE SECONDS.**
2. Press and release the ON button **8** times.
The status light starts rapidly flashing green and red.
3. Press and hold the ▲ button for 4 seconds.
The status light will turn orange for 1 second,
and then start flashing green or red.
4. Press OFF.
5. After you have successfully configured the antenna, you must configure your receiver for mobile use.

To configure your receiver for mobile use, **go to page 23 and run the check switch test.**

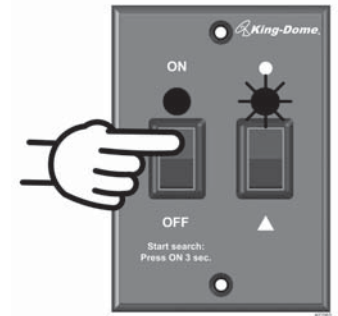

Bell TV SD and HD (satellites 82, 91)

1. On the King-Dome controller, press and release the ON button.
Wait for status light to flash orange, then **WAIT 4 MORE SECONDS.**
2. Press and release the ON button **32** times.
The status light starts rapidly flashing green and red.
3. Press and hold the ON button for 4 seconds.
The status light will turn orange for 1 second,
and then start flashing green or red.
4. Press OFF.
5. After you have successfully configured the antenna, you must configure your receiver for mobile use.

To configure your receiver for mobile use, **go to page 23 and run the check switch test.**

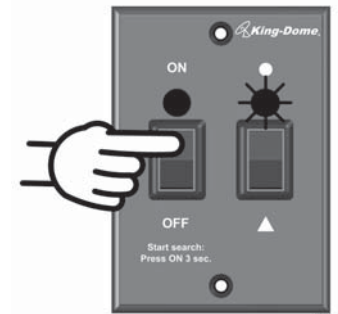

ANTENNA CONFIGURATION USING #1844 KEYPAD

NOTE: If you don't have the Keypad tool and are using the wall mount controller for programming, go to page 14.



Find your service in the chart below.
Determine your Switching Mode and Provider Code, and then **go to page 20**.

SWITCHING MODE AND PROVIDER CODE CHART

Service	Satellites	Switching Mode	Provider Code
DIRECTV ¹			
DIRECTV SD (Factory Preset)	101	02	01
DIRECTV SD with Locals	101, 119	16	01
DISH			
DISH SD (SW21 Switch)	110, 119	26	10
DISH SD and HD (SW64 Switch)	110, 119, 129	62	10
DISH SD and HD Alternate (SW64 Switch)	61.5, 110, 119	66	10
Bell TV			
Bell TV SD	91	02	91
Bell TV SD and HD	82, 91	26	82

NOTE: ¹ The King-Dome will not receive HD channels broadcast from DIRECTV's Ka band satellites at 99° and 103°.

Perform the programming steps on these two pages using the codes determined from the chart on page 19 (**EXCEPT DIRECTV SD SERVICE - SEE BOX BELOW**).

DIRECTV SD Service Only!

The King-Dome is factory pre-set for the DIRECTV 101 satellite. Unless the antenna has been configured for another option since leaving the factory, do the following:

Set your receiver as shown in this box.

If you have a newer receiver or current software, choose the following dish configuration settings (do this through the receiver's satellite set-up menu screens):

Dish Type: 01: 18" Round Switch Type: 02: Multiswitch
If you have an older receiver, choose round dish-1 satellite.

Configuration is complete. **Go to page 26.**

SET SATELLITE SWITCHING MODE

1. Unplug the controller and plug in the Keypad.
2. Press ON.
3. Press *** 46 #** to display the current satellite switching mode.
4. To change the satellite switching mode, press *** 96 #**
*** 66 #**
*** 88 #**
5. Press the UP and DOWN arrows (2 and 8 keys) to choose your desired switching mode from the chart on page 19.
6. Press *** 47 #** to lock in setting.
7. Turn unit OFF and back ON to save setting.
8. Press *** 46 #** to display and verify setting for new satellite switching mode.
9. Continue with **SET SERVICE PROVIDER CODE** on next page.



SET SERVICE PROVIDER CODE

1. Press *** 24 #** to display the current service provider code (see chart on page 19).

2. To change the current service provider, press

- * 96 #**
- * 66 #**
- * 88 #**



3. Press the UP and DOWN arrows (2 and 8 keys) to choose your desired service provider from the chart on page 19.

4. Press *** 25 #** to lock in setting.

5. Turn unit OFF and back ON to save setting.

6. Press *** 24 #** to display and verify setting for new service provider.

7. Press OFF.

8. Unplug the Keypad and plug the controller back in.

9. Continue with RECEIVER CONFIGURATION below.

RECEIVER CONFIGURATION

DIRECTV SD with Locals

If you have a newer receiver or current software, choose the following dish configuration settings (do this through the receiver's satellite set-up menu screens):

Dish Type: 02: 3-LNB (18 x 20") Switch Type: 02:Multiswitch

If you have an older receiver, choose oval dish-2 satellites.

Configuration is complete. **Go to page 26.**

For all of the following, **go to page 23** and run the check switch test.

DISH SD

DISH SD and HD

DISH SD and HD Alternate

Bell TV SD

Bell TV SD and HD



This page intentionally left blank.

DISH AND BELL TV CHECK SWITCH TEST

IMPORTANT! YOU MUST HAVE COMPLETED THE ANTENNA CONFIGURATION (PAGE 13), AND PERFORMED A SUCCESSFUL SEARCH (STEP 2 BELOW), BEFORE RUNNING THE CHECK SWITCH TEST (STEP 3 BELOW).

NOTE: For automatic satellite switching, King Controls recommends using a DISH model 311 receiver for **DISH SD**, and a DISH model ViP211z, ViP211k or a ViP211 HDTV receiver for **DISH SD and HD** and **DISH SD and HD Alternate**. King Controls does not recommend the use of dual tuner receivers or receivers with built-in recorders when using the automatic satellite switching feature. The King-Dome will not work with DIRECTV SWM only receivers.

If you do not have a clear view of all satellites, the switch will not load correctly.

The SW21 and SW64 switches are a receiver software configuration that is loaded into the receiver after successfully running a check switch test with the dish locked on and configured for the appropriate service.

This one time procedure will not need to be repeated after successful installation, unless:

- check switch test is run again while connected to a home dish system.
- check switch test is run when a receiver is not connected.
- you travel outside the coverage area of either **DISH SD and HD** or **DISH SD and HD Alternate** and switch to the other.
- you are parked in an area where the selected satellites are blocked, but are able to select alternate satellites and get signal.

- Turn on the TV and satellite receiver.
- On the King-Dome controller, press and hold the ON button for **3 FULL SECONDS**.

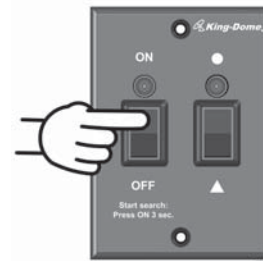

The antenna will locate all of the appropriate satellites before completing the search process.

After the satellites have been located and the acquisition process is complete, the status light will be steady green.

If you configured the antenna for DISH SD and HD and the antenna cannot acquire the 110, 119, and 129 satellites, you may need to configure the antenna for DISH SD and HD Alternate.

- On the receiver remote, press **MENU, 6, 1, 1**.
- Highlight "Check Switch" and press **SELECT**.

NOTE: Some receivers may prompt you to select "Check Switch" a second time to initiate the test.

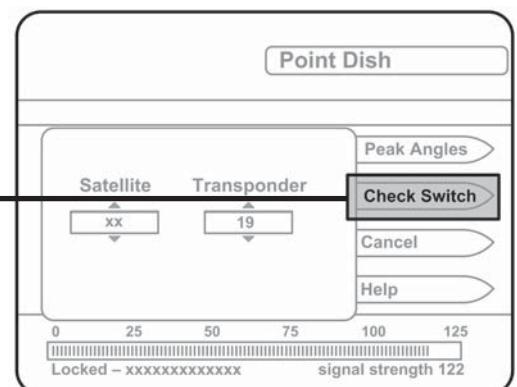

(Continued on next page)

Screen graphics may vary.

NOTE: Not all receivers will display a screen with options that include “superDISH” and “Alternate” boxes.

5. Make sure “superDISH” and “Alternate” boxes are **NOT** selected.
6. Highlight “Test” and press **SELECT**.

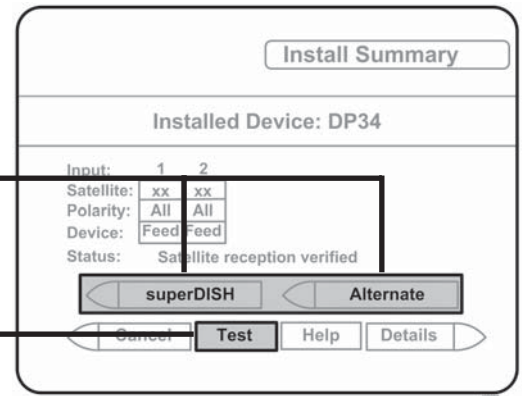

The receiver will perform a check switch test, during which time the antenna will periodically move back and forth between satellites. This process will take several minutes.

7. When test is complete, a screen similar to one **below or on the next page** should appear. After screen verification, continue with check switch test on next page.

Because receivers are always changing, screen graphics may vary.

DISH SD

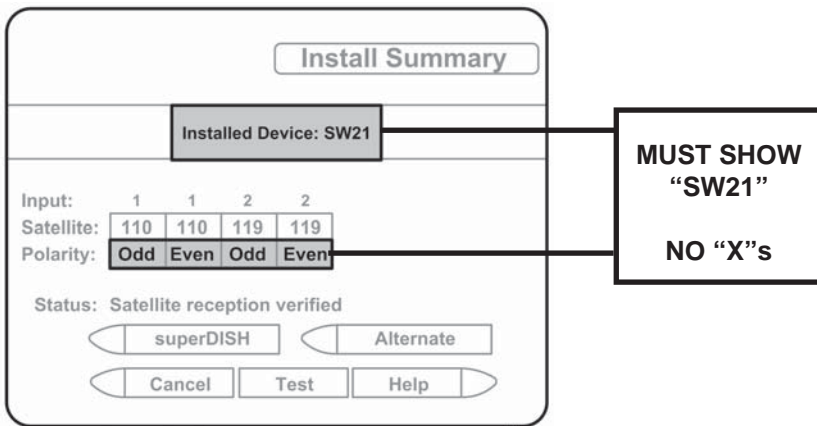

**MUST SHOW
“SW21”
NO “X”s**

DISH SD and HD

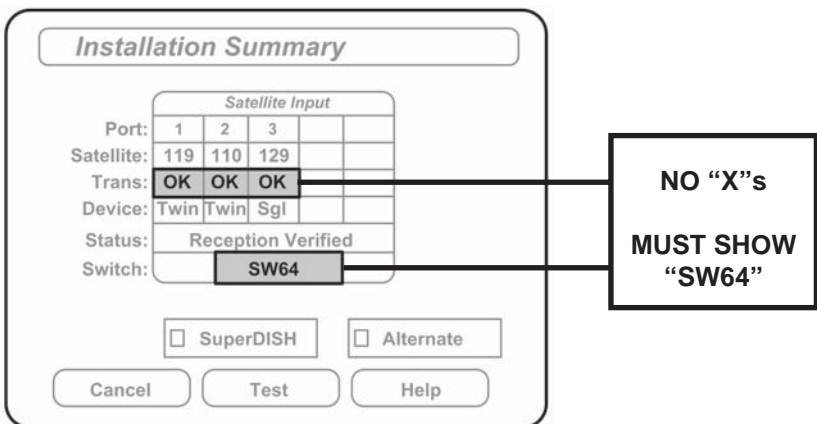

**NO “X”s
MUST SHOW
“SW64”**

DISH SD and HD Alternate

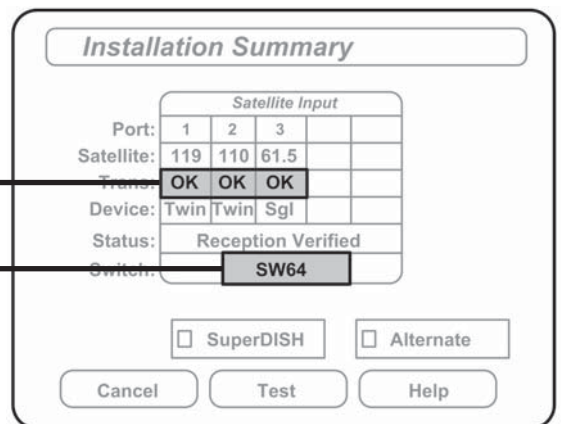

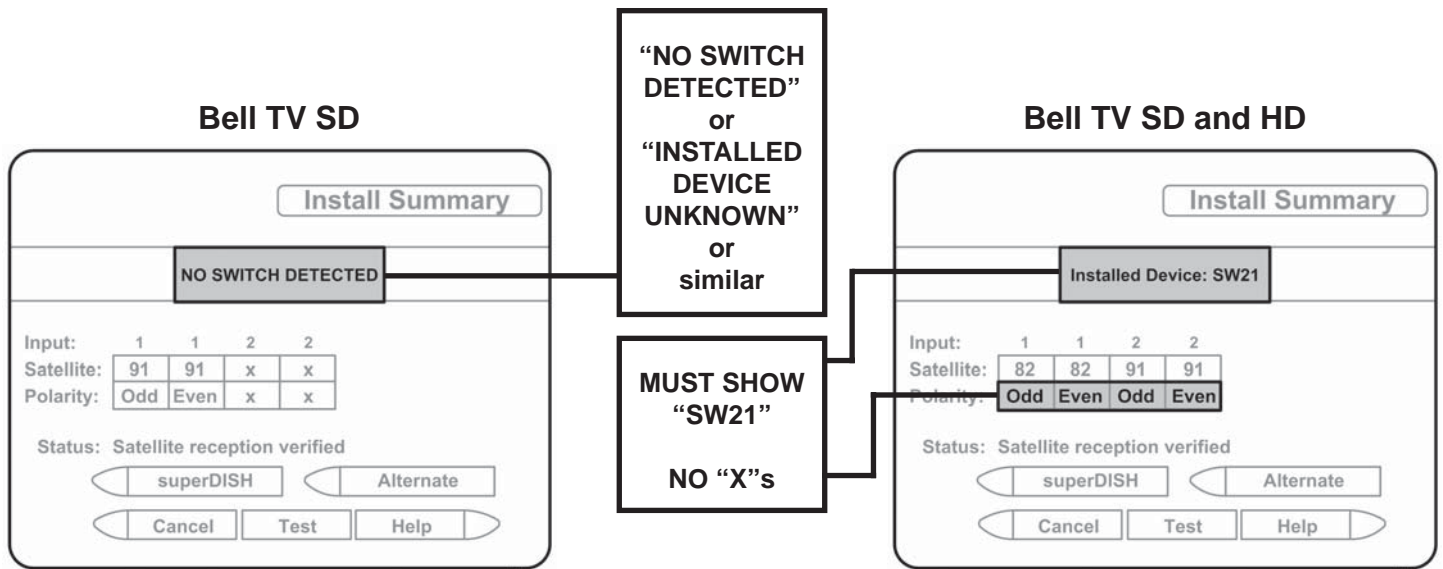

If indicated results are not obtained, go back to Step 3 and run test again. Contact King Controls if the check switch fails to load after 4 attempts.

8. When the installation summary shows the successful check switch test results, save the settings, exit to the main menu screen and wait for programming to download.
9. **DISH SD and HD** and **DISH SD and HD Alternate** only: Verify that your saved settings show your desired satellite trio: 61.5, 110, 119 or 110, 119, 129.

Configuration is complete. Go to page 26, OPERATION.

IMPORTANT: Unless you have DIRECTV service for single satellite 101, you must have completed the antenna configuration as instructed in Section 4 ANTENNA CONFIGURATION.

There must be a clear “line of sight” to the southern sky. Mountains, buildings, trees, telephone poles, etc. can all block the satellite signal from reaching the antenna.

The distance driven since last performing a search may affect how long it takes for the King-Dome to find the satellite.

This King-Dome will not receive HD channels broadcast from DIRECTV’s Ka band satellites at 99° and 103°.

STATIONARY SEARCH

1. Turn on TV and Receiver. “Searching for Satellite” or similar will appear on TV screen.

2. On King-Dome controller, press and hold ON for **3 FULL SECONDS.**

Power light turns steady GREEN.

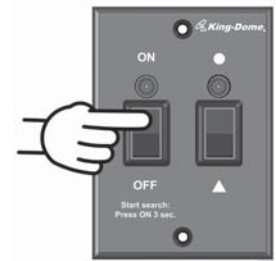

STATUS LIGHT

SYSTEM STATUS

- a) flashes a variety of colors for about 30 seconds unit performs self-diagnostic
- b) RED-flashing search in progress
- c) GREEN-flashing (may start flashing RED again) potential satellite found
- d) GREEN-steady satellite(s) found and search is complete

3. When the status light is steady green, select a channel or the program guide to view your programming. Enjoy!

(DO NOT TURN THE KING-DOME OFF IF USING THE AUTOMATIC SATELLITE SWITCHING FEATURE.)

NOTE: If the status light is steady GREEN and your programming does not appear, press the reset button on your DIRECTV receiver. If using DISH or Bell TV, hold the receiver power button in for 10 seconds to reset your receiver. Consult your receiver owner’s manual for further details. Note that it may take several minutes for the guide to re-download.

When receiver reset is complete and the guide is downloaded, select a channel or the program guide to view your programming.

AUTOMATIC SATELLITE SWITCHING

After you have properly configured the King-Dome antenna for your satellite service, the King-Dome will automatically switch between satellites by simply selecting your desired channel using the receiver's remote control.

NOTE: For better performance when using the automatic satellite switching feature, change channels by selecting your program from the channel guide rather than channel surfing.

It is common for the picture to pixel or display an error message when the antenna is switching between satellites, or if the signal has been temporarily blocked. PLEASE BE PATIENT. THE PICTURE WILL RETURN.

If an error message appears for an extended period, selecting CANCEL may help clear the message more quickly.

DISH SD and HD users: If you are unable to receive all of your HD programming, you may need to choose **DISH SD and HD Alternate**. See ANTENNA CONFIGURATION for details.

IN-MOTION OPERATION (KD3000 ONLY)

1. Perform a stationary search as shown on the previous page.
2. Allow your programming to download.

3. Press ▲ .

STATUS LIGHT	SYSTEM STATUS
a) alternating colors	initializing
b) GREEN-flashing	potential satellite found
c) GREEN-steady	target satellite found (tracking)

When the status light is steady green, the target satellite is found and the unit is tracking.

ALTERNATE SEARCH METHOD (Above method is the manufacturer's preferred method)

1. Press ON.
2. Press ▲ . Before putting the vehicle into motion, wait for the status light to turn steady green and your programming to download.

NOTE: While driving and in tracking mode, objects such as bridges, buildings and trees may occasionally block the satellite signal from reaching the antenna. Line of sight obstructions may cause the picture on your TV to freeze, pixel or be lost temporarily. PLEASE BE PATIENT. THE PICTURE WILL RETURN.

If the antenna does not sense vehicle motion after several minutes, it will enter sleep mode. The antenna will automatically wake and begin tracking if it senses vehicle motion or a severe drop in satellite signal.

When you park for the evening or any extended period, it is recommended that you perform a stationary search.

INITIAL SETUP FOR SECOND RECEIVER

With the second receiver disconnected from the King-Dome, use your DISH remote control and press **MENU, 6, 1, 1** to display the *Point Dish* screen.

Use the arrow buttons on the remote to highlight “Check Switch” and press **SELECT**.

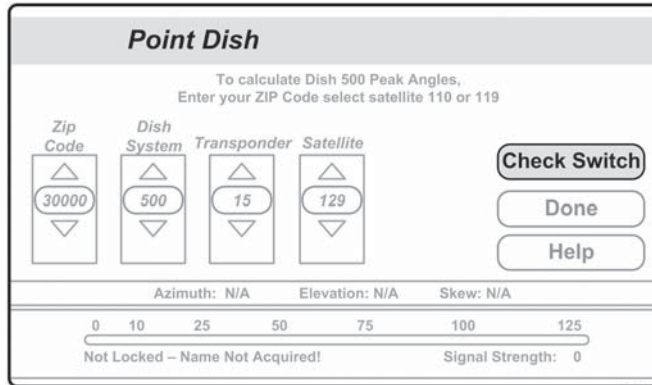

Verify “SuperDISH” and “Alternate” are not selected. Verify “Test” is highlighted and press **SELECT**.

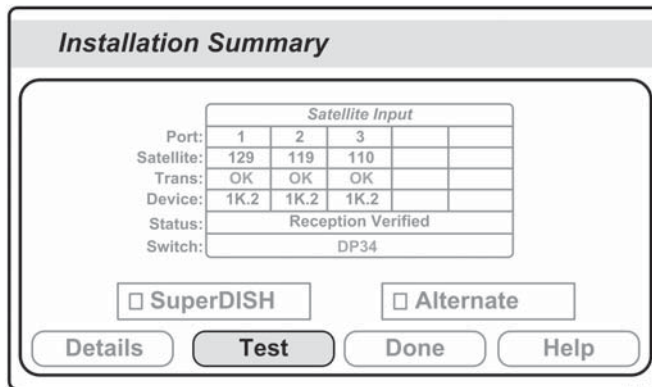

When test is complete, highlight “Save” and press **SELECT**. After successfully saving the results, connect the AUX coax connection of the King-Dome to SAT IN on the second receiver.

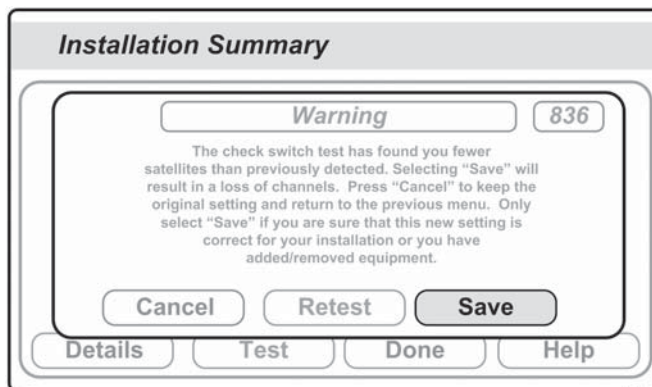

See the next page for downloading programming to the second receiver.

DOWNLOADING PROGRAMMING TO THE SECOND RECEIVER

The channels available on the second receiver are determined by the channel/satellite selected by the main receiver. For example, if you select a channel on the main receiver that is broadcast from the 119 satellite, then the second receiver will be able to view any channel broadcast from the 119 satellite after performing the following procedure:

With the antenna locked on, re-set the second receiver by pressing the POWER button on the front panel for 10 seconds. The TV picture will go away and should reappear within two minutes. The receiver will then download the program guide to show only the channels available on the current satellite as determined by the channel selected on the main receiver. Downloading the new program guide can take up to five minutes to complete.

If you switch channels on the main receiver to one that is broadcast from a different satellite, (i.e. your channel was broadcast from satellite 119 but your new channel is broadcast from the 110 or 129), the antenna will automatically switch to the new satellite and programming will be lost on the second receiver until you either:

- Select a channel on the main receiver that is broadcast from the previous satellite (satellite 119 in this example).

(or)

- Reset the second receiver to download the program guide for the newly selected satellite (satellite 110 or 129 in this example).

TIP: Most DISH HD channels are broadcast from the 129 satellite location. Selecting an HD channel on the main receiver before re-setting the second receiver will provide independent viewing of most available HD channels on either receiver.

Section 7 TROUBLESHOOTING

SYMPTOM	POSSIBLE REASON	COURSE OF ACTION
STATIONARY		
Unit does not find satellite. (STATUS light flashes red or green.)	Did not hold ON/SEARCH button for <u>3 FULL SECONDS</u> .	Hold ON/SEARCH button for <u>3 FULL SECONDS</u> .
STATUS light flashes orange.	Before search: bad coax connection. After unsuccessful search (approximately 25 minutes): obstruction in line of sight between dome and satellite.	Check external coax connections. Verify coax cable is connected to correct port on receiver. Move vehicle to have unobstructed view of southern sky.
STATUS light does not stop rapidly flashing red and green.	Self check failed: potential motor problem.	Call King Controls at (952) 922-6889.
STATUS light does not turn on or is dim.	Bad power source (low voltage). Bad power or controller cable connection at dome. Bad controller cable connection at controller.	Call King Controls at (952) 922-6889.
STATUS light is steady green but no picture.	Satellite receiver is off or requires reset. King-Dome is factory set for DIRECTV Single Satellite 101 and you have a different service.	Turn receiver on or reset. Configure the King-Dome for your service (page 13).
Antenna begins searching but then shuts off by itself.	Low voltage/power.	Charge batteries. Install AC to DC power converter to power King-Dome and supply consistent voltage.
IN MOTION		
Picture freezes, pixelates, or is temporarily lost.	Objects such as bridges, buildings, and trees may temporarily block signal from reaching the antenna.	Problem will stop when objects no longer block signal.
STATUS light is steady green but no picture.	Satellite receiver is off or requires reset. King-Dome is factory set for DIRECTV Single Satellite 101 and you have a different service.	Turn receiver on or reset. Configure the King-Dome for your service (page 13).

Section 8 MAINTENANCE

King-Dome satellite systems are designed to be maintenance and trouble free.

For optimum signal strength, keep the dome clean from dirt, bugs, and other debris. Periodic washing of the dome with mild soap and water is recommended.

IMPORTANT! Do not power wash the King-Dome.

If you plan on storing your vehicle for long periods of time, it is recommended that the system be put through a search procedure on a quarterly basis to keep all moving parts in good working order.

If you have any comments or questions, please contact the King Controls Service Department at (952) 922-6889, or via email at info@kingcontrols.com.

Rain Fade

Rain or dew on the dome can cause signal interference and make the digital picture freeze, pixel or go out altogether. This loss of signal is commonly referred to as “rain fade” and is caused by the combination of water in the atmosphere and water on the dome surface.

To minimize this issue and eliminate the effects of water on the dome, apply King Controls **Dome Magic**[®] rain fade solution to the dome. This will prevent water from sticking to the dome surface and blocking the signal. For additional details on **Dome Magic**[®] rain fade solution please contact an authorized King-Dome dealer or call King Controls at (952) 922-6889.



Single Application Packet #1830-SP



Spray Can #1830

NOTE: *Dome Magic*[®] will discolor black domes or domes painted a dark color.

Section 9 LIMITED WARRANTY

Every new King-Dome Satellite System is thoroughly inspected and tested before leaving the factory, and is covered by the following two year parts and one year labor limited warranty from the date of original purchase:

- Two year parts warranty: The customer is not responsible for the cost of replacement parts if the original part is determined to be defective under the terms of the warranty. The customer is responsible for the cost of replacement parts after two years.
- One year labor warranty: The customer is not responsible for labor costs to repair unit if unit falls under the terms of the warranty. Any warranty labor outside of that performed at the factory is not covered unless the product has been installed by an authorized dealer/installer or OEM manufacturer. The customer is responsible for all labor costs after one year.

Should any trouble develop during the warranty period, contact King Controls. You must contact King Controls before the warranty period expires. The customer must supply proof of purchase (such as a dated sales receipt) when requesting warranty service. If customer cannot supply proof of purchase, warranty period shall start 30 days after date of manufacture.

Only King Controls and certified dealers are authorized to perform warranty evaluations and repairs. Depending upon the problem, King Controls may authorize the dealer to perform the necessary repairs, or may have the unit returned to King Controls for repairs.

A certified dealer must not perform any repair without first contacting King Controls for a Service Order Number. King Controls will advise the dealer on how to proceed with any repairs.

If it is determined that the unit needs to be returned to King Controls, customer must return COMPLETE product, freight prepaid, to: **King Controls, 11200 Hampshire Avenue South, Bloomington, MN 55438-2453.**

If inspection shows the trouble is caused by defective workmanship or material, King Controls will repair (or at its option, replace) without charge.

When returning product, King Controls will supply an RMA number (Return Merchandise Authorization). This number must be clearly written on the box. Failure to clearly write RMA number on box may result in delays in processing claim. Along with product, customer should include in the box: his/her name, address, daytime phone number, proof of purchase and description of the problem.

This warranty does not cover installation and external wiring, or remanufactured units. This warranty is not transferable from the original owner.

Due to the expanding and changing TV market, King Controls cannot be held responsible for changes made to satellite services. Software updates to address such issues are not covered under warranty.

This warranty also does not apply where:

- The product has been abused, misused, improperly installed or improperly maintained.
- Repairs have been made or attempted by others that are not certified by King Controls to do such repairs.
- Repairs are required because of normal wear and tear.
- Alterations have been made to the product.
- The dome cover has been removed without authorization.
- Supplied grease not used in the external coax connections as specified in the instructions (non-portable only).
- Damage has been caused by power washing.
- Circumstances beyond the control of King Controls cause the product to no longer operate correctly.
- Customer is not the original owner.

In no event shall King Controls be liable for any indirect, incidental, or consequential damages from the sale or use of the product. This disclaimer applies both during and after the term of the warranty.

King Controls disclaims liability for any implied warranties, including implied warranties of “merchantability” and “fitness for a specific purpose,” after the one year term of this warranty.

This warranty gives you specific legal rights, and you may also have other rights, which vary from state to state. Some states do not allow the exclusion or limitation of incidental or consequential damages, so the above limitation or exclusion may not apply to you. Some states do not allow limitations on how long an implied warranty lasts, so the above limitation may not apply to you.



11200 Hampshire Avenue South, Bloomington, MN 55438-2453
Phone: (952) 922-6889 Fax: (952) 922-8424

www.kingcontrols.com