



DESIGNED TO MOVE [YOU][®]

JWM40

MOBILE AUDIO SYSTEM

Installation and Owner's Manual

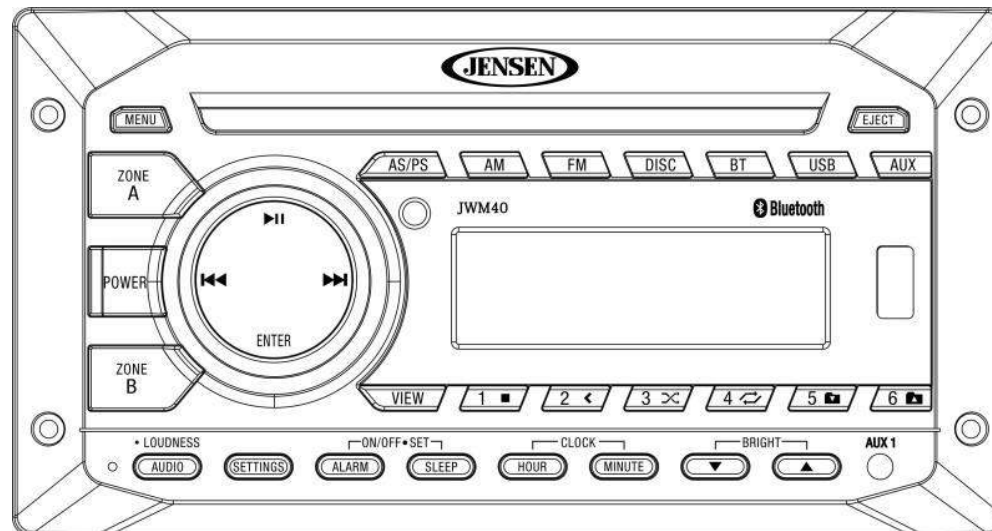

CONTENTS

| | |
|--------------------------------|----|
| Introduction | 1 |
| Disc Notes..... | 2 |
| Installation..... | 3 |
| Wiring..... | 4 |
| Basic Operation..... | 5 |
| Tuner Operation | 8 |
| Disc Operation | 9 |
| CD Operation | 9 |
| DVD Operation..... | 10 |
| MP3/USB Operation..... | 12 |
| Bluetooth Operation | 14 |
| Remote Control Operation | 16 |
| DVD Settings..... | 18 |
| Care and Maintenance..... | 19 |
| Troubleshooting | 19 |
| Specifications | 20 |
| FCC Notes | 20 |

INTRODUCTION

Thank You!

Thank you for choosing a Jensen product. We hope you will find the instructions in this owner's manual clear and easy to follow. If you take a few minutes to look through it, you'll learn how to use all the features of your new Jensen receiver for maximum enjoyment.

Features

Features of Jensen JWM40 mobile audio system include:

- Digital AM/FM Tuner/30 Preset stations (12 AM/18 FM)
- Bluetooth Ready with A2DP/AVRCP Streaming Audio
- Electronic Bass, Treble, Balance and Fader Controls
- Skip Protected Disc Mechanism
- DVD/CD-R/RW and MP3 Compatible
- Time/Alarm Clock
- LCD Backlight Control
- 1/8" Front Auxiliary Audio/Video Input
- Rear Audio RCA Inputs/Outputs
- USB Playback of MP3 Files
- 2 Zone / 4 Speaker Output
- Wireless Remote Control Included

Precautions

Use the Proper Power Supply

This product is designed to operate with a 12 volt DC, negative ground battery system (the standard system in a North American vehicle).

Protect the Disc Mechanism.

Avoid inserting any foreign objects into the slot of this player. Failure to observe this may cause malfunction due to the precise mechanism of this unit.

Use Authorized Service Centers

Do not attempt to disassemble or adjust this precision product; contact a professional for assistance.

Avoid Moisture

To reduce the risk of fire or electric shock, do not expose this equipment to rain or moisture.

Avoid Cleaning Products

The front of this unit should only be cleaned with a slightly damp cloth. Do not use cleansers.

Use Recommended Accessories.

TO REDUCE THE RISK OF FIRE OR ELECTRIC SHOCK AND ANNOYING INTERFERENCE, USE ONLY THE RECOMMENDED ACCESSORIES.

CAUTION: This mobile DVD player is a Class I laser product that uses a visible/invisible laser beam which could cause hazardous radiation exposure if improperly directed. Be sure to operate the mobile DVD player as instructed. Use of controls or adjustments or performance of procedures other than those specified herein may result in hazardous radiation exposure. Do not open covers and do not attempt to repair the unit yourself. Refer servicing to qualified personnel.

Packing List

JWM40

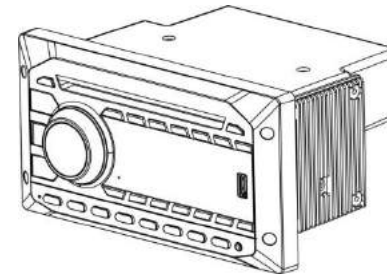

Remote Control

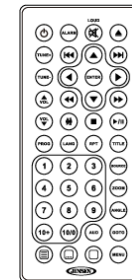

20-PIN Speaker Wire

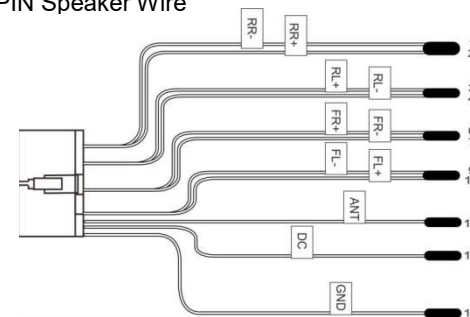



DISC NOTES

Depending on the recording status, conditions of the disc, and the equipment used for recording, some CD-Rs/CD-RWs may not play on this unit. For more reliable playback, please adhere to the following recommendations:

- Use CD-RWs with speed 1x to 4x and write with speed 1x to 2x.
- Use CD-Rs with speed 1x to 8x and write with speed 1x to 2x.
- Do not play a CD-RW which has been written more than 5 times.

Compatible Disc Types



Table 1: General Disc Information

| Symbol | 12cm Disc Properties | Max Play time |
|--|-----------------------------------|--------------------------------|
|  | Single side single layer (DVD-5) | (MPEG 2 Method) 133 minutes |
| | Single side double layer (DVD-9) | 242 minutes |
| | Double side single layer (DVD-10) | 266 minutes |
| | Double side double layer (DVD-18) | 484 minutes |
|  | Single side single layer (VCD) | MPEG 1 Method 74 minutes |
|  | Single side single layer | 74 minutes |

NOTE: CD-R and CD-RW discs will not play unless the recording session is closed and the CD is finalized.

Disc Maintenance

- A dirty or defective disc may cause sound dropouts while playing. Before playing, wipe the disc using a clean cloth, working from the center hole towards the outside edge. Never use benzene, thinners, cleaning fluids, anti-static liquids or any other solvent.

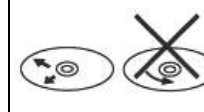
| | | | |
|---|---|---|---|
|  |  |  |  |
| Insert label side up, | Do not bend. | Never touch the underside of the disc | Wipe clean from this center to the edge. |

- Be sure to use only round CDs for this unit and do not use any special shape CDs. Use of special shape CDs may cause the unit to malfunction.
- Do not stick paper or tape on the disc. Do not use CDs with labels or stickers attached or that have sticky residue from removed stickers.
- Do not expose discs to direct sunlight or heat sources such as hot air-ducts, or leave them in a vehicle parked in direct sunlight where there can be a considerable rise in temperature inside the vehicle.

NOTE: A disc may become scratched (although not enough to make it unusable) depending on how you handle it and other conditions in the usage environment. These scratches are not an indication of a problem with the player.

INSTALLATION

It's a good idea to read all of the instructions before beginning the installation. We recommend having your Jensen JWM40 installed by a reputable RV dealership.

Tools and Supplies

You will need these tools and supplies to install your JWM40:

- Phillips screwdriver
- Wire cutters and strippers
- Tools to remove existing radio (screwdriver, socket wrench set or other tools)
- Electrical tape
- Crimping tool
- Volt meter/test light
- Crimp connections
- 16 gauge wire for power connections
- 16 - 18 gauge speaker wire
- Four M3x20mm (3/32 x 0.75") screws

Disconnecting the Battery

To prevent a short circuit, be sure to turn off the ignition and remove the negative (-) battery cable prior to installation.

NOTE: If the JWM40 is to be installed in a vehicle equipped with an onboard drive or navigation computer, do not disconnect the battery cable. If the cable is disconnected, the computer memory may be lost. Under these conditions, use extra caution during installation to avoid causing a short circuit.

Selecting the Mounting Location

Select a mounting location, taking care to avoid the following:

- Places exposed to heat-radiating appliances such as electric heaters
- Adjacent to other equipment that radiates heat
- Poorly-ventilated or dusty places
- Moist or humid locations

Preparing the Opening

Use the mounting hole diagram (below) to measure and cut a mounting hole, then mount the unit using four M3x20mm screws.

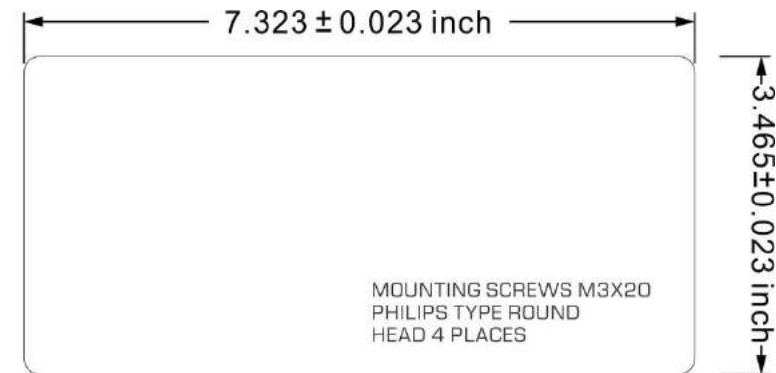

NOTE: Before cutting the mounting hole, make sure the area behind the mounting location is clear of wires, fuel and vacuum or brake lines.

WIRING

The wiring diagram depicts all the wiring connections required for proper operation of the unit.

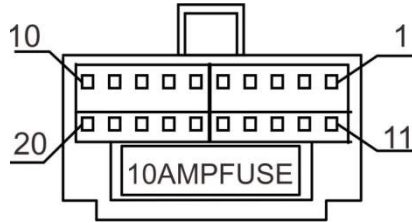

DETAIL A
SHOWN FROM PIN VIEW

| PIN NO. | WIRE COLOR | DESCRIPTION |
|---------|--------------|---------------------------|
| 1 | VIOLET/BLACK | REAR RIGHT SPEAKER (-) |
| 2 | VIOLET | REAR RIGHT SPEAKER (+) |
| 3 | GREEN | REAR LEFT SPEAKER (+) |
| 4 | GREEN/BLACK | REAR LEFT SPEAKER (-) |
| 5 | N/A | N/A |
| 6 | GRAY | FRONT RIGHT SPEAKER (+) |
| 7 | GRAY/BLACK | FRONT RIGHT SPEAKER (-) |
| 8 | N/A | N/A |
| 9 | WHITE/BLACK | FRONT LEFT SPEAKER (-) |
| 10 | WHITE | FRONT LEFT SPEAKER (+) |
| 11 | N/A | N/A |
| 12 | N/A | N/A |
| 13 | N/A | N/A |
| 14 | BLUE | AMP REMOTE (+12VDC 100mA) |
| 15 | RED | +12VDC SWITCHED |
| 16 | BLACK | GROUND |
| 17 | N/A | N/A |
| 18 | N/A | N/A |
| 19 | N/A | N/A |
| 20 | N/A | N/A |

WARNING: Wiring harness comes with stripped and tinned leads to aid in the installation process. Any unused speaker wires must have their exposed ends cut off or insulated individually.

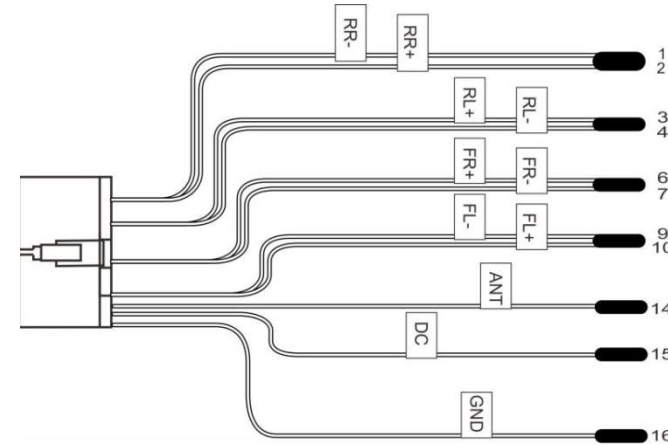

CONNECTIONS

The diagram below depicts all the available audio/video connections available to use with your system.

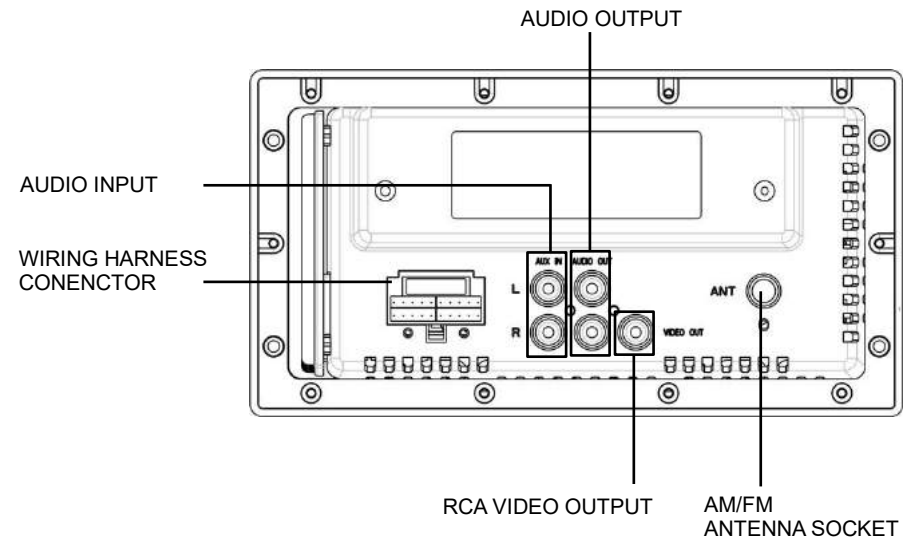

BASIC OPERATION

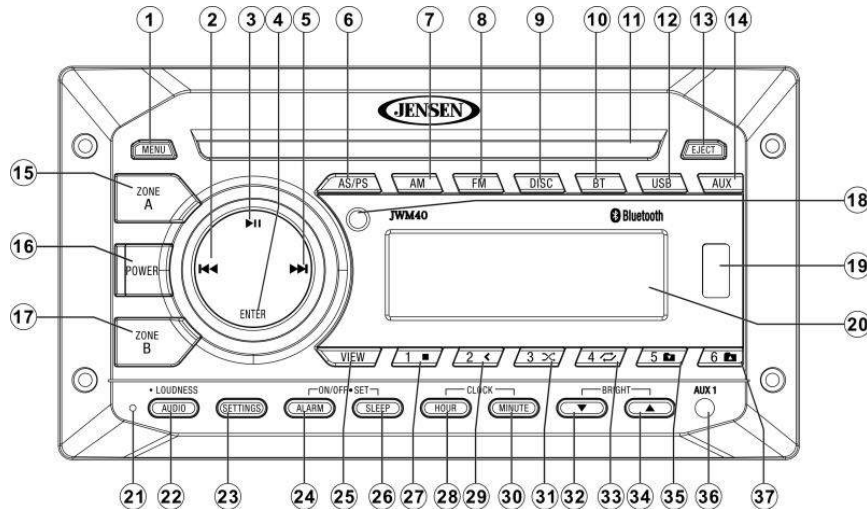

Power

Press the **POWER** button (16) to turn the unit on or enter standby mode. The unit will resume at the last mode (Tuner, Aux, etc.) after turn on.

Volume control

Rotate the **VOL** encoder knob control clockwise to increase or counter-clockwise to decrease the volume output.

The maximum volume setting is "40". While adjusting the volume, the LCD displays numerical representation of the level.

Audio Menu Setting

Press the **AUDIO** button (22) to step through the following audio adjustment options. Rotate the **VOL/ENTER** encoder knob control to adjust the selected audio feature.

Audio Adjustment

- **BAS**: Adjust the Bass level from "-7" to "+7".
- **TRE**: Adjust the treble from "-7" to "+7".
- **BAL**: Adjust the speaker output balance between "L7" (left) and "R7" (right). "BAL 0" indicates an equal balance between the left and right speakers.
- **FAD**: Adjust the speaker fade between "R7" (rear) and "F7" (front). "FAD 0" indicates and equal balance between the rear and front speakers.

This function will time out after ten seconds of inactivity and the unit will resume normal operation.

Loudness

Press the **LOUD** button (22) to toggle the loudness function on/off.

Mute

Press the **MUTE** button (3) to silence the audio output in tuner, CD, DVD, BT, USB or auxiliary input mode. Press again to restore the previous volume level.

Liquid Crystal Display (LCD)

The liquid crystal display (LCD) panel (20) displays the frequency, time and activated functions.

Press the **BRIGHT UP** button (34) to increase the LCD brightness and press the **BRIGHT DOWN** button (32) to decrease the LCD brightness from "LEVEL 0" (off) to "LEVEL 9" (brightest).

NOTE: *When subjected to cold temperatures for an extended period of time, LCD panels will take longer to illuminate and the display visibility may slightly decrease. Optimal LCD operation will return to normal when the temperature increases to a normal range.*

System menu setting

1. Press the **SETTING** button (23) to enter the system menu.
2. Press **SETTING** button or press the |<< or >>| (2,5) to choose the following system menu list:
3. Once the desired menu item appears on the display, adjust that option by rotating the volume encoder knob clockwise or counter-clockwise within 10 seconds.
4. Press the **ENTER** knob button (4) to confirm your selection and exit system menu. The unit will automatically exit the audio menu after 10 seconds of inactivity.

The following items can be adjusted:

- **Beep On/Off**: Turn the audible beep On/Off (heard when functions /buttons are selected).
Note: Beep tone off will not affect the audible tone of the alarm clock.
- **LCD Brightness**: Adjust the brightness of the LCD backlight from "BRI 0" (off) to "BRI 9" (Brightest).

Setting the Bluetooth

- Bluetooth (On/Off): Choose “Bluetooth On” or “Bluetooth Off”.
- Bluetooth Device (Locked/Unlocked, Disconnect/Connect, Delete): view, lock and delete from a list of previously paired mobile device models.
- Bluetooth Pair: Press “**ENTER**” knob to automatically pair a device.
- PRESET Volume (PVOL): Select an automatic turn on volume

Reset

Press **ENTER** knob button to reset the JWM40 to factory default.

Auxiliary Input Function

Press the **AUX** button (14) repeatedly to toggle between AUX IN1 and AUX IN2 from any other mode when a portable audio device is connected to the unit. To connect a portable audio device, insert a standard 3.5mm (audio line output or headphone output from your portable CD / MP3 / iPod or other media player) into the AUX A/V IN connector (AUX IN1) (36) on the front of the unit or the AUDIO IN (AUX IN2) on the back of the unit (see “Wiring” on page 4).

Auxiliary Input Connector

For front panel A/V input, an external audio/video (A/V) source such as a video game player, camera, etc. can be connected to the front panel A/V input with a proper A/V cable adapter (not included). Please note that there are several different 3.5mm A/V cable standards, so refer to the diagram below for proper configuration. Connect the device to the AUX A/V IN connector (36) on the front panel.

In addition to front panel auxiliary input source, the unit can also be connected to the RCA audio input through the AUX AUDIO INPUT jack on the rear of the unit.

Press the **AUX** button (14) to directly access auxiliary input modes (AUX 1 IN and AUX 2 IN) from any other mode when a portable audio device is connected to the unit.

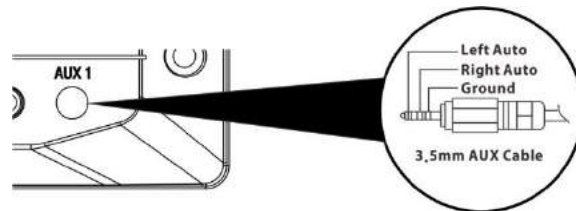

USB Interface Connector

You can connect a USB device directly to USB interface (19) on the front of the

JWM40 for playback of compatible files. Playback begins automatically. Press the USB button (12) to switch to USB mode from another source. Refer to “MP3/USB Operation” on page 12 for additional operating instructions.

NOTE: USB will not support Apple device playback. The USB input supplies up to 1A of charging current.

Clock Display

Press the **VIEW** button (25) to alternate between playing time and clock time while in Tuner, CD, DVD, USB or auxiliary input mode.

Clock Setup

Press and hold the clock **HOUR** or **MINUTE** button (28, 30) to access clock setup mode. The number representing the hours and minutes will flash. Press the **HOUR** button (28) to adjust the hour and press the **MINUTE** button (30) to adjust minutes. The new time will be saved five seconds after the last adjustment is made.

Sleep Mode

The Sleep Timer will automatically turn off the JWM40 in the designated number of minutes. To set the Sleep Time, press the **SLEEP** button (26) and the sleep time will appear in the display with the number representing the minutes (SLEEP 0). Press **SLEEP** button repeatedly to change the sleep time from 0 (OFF), 15, 30, 45 or 60 minutes.

Alarm Setting

To set the alarm, *press and hold* the **ALARM** button (24) for 2 seconds and the clock will begin flashing. Press the **HOUR** button to adjust the hour once at a time or *press and hold* to advance rapidly. Repeatedly press the **MINUTE** button to adjust the minute one digit at a time, or *press and hold* to advance rapidly.

Press the **ALARM SET** or **ENTER** knob button to save the alarm time.

Once a time is set, press **ALARM** (24) to turn the alarm function on or off.

Remote Sensor

Infrared receiver (18) is located on the upper left of front panel to receive infrared signal emitted by the remote control.

Speaker Output

The two speaker output buttons (15, 17) (Zone A, Zone B) control speaker zones output from the radio. Press any of the two buttons to turn the corresponding speaker

zone on or off. SPK A (Zone A), SPK B (Zone B) will appear on the display.

Reset

The reset button should be activated for the following reasons:

- Initial installation of the unit when all wiring is completed
- Function buttons do not operate
- Error symbol on the display

Use a ball point pen or similar object to press the **RESET** button (21). This may be necessary should the unit display an error code.

TUNER OPERATION

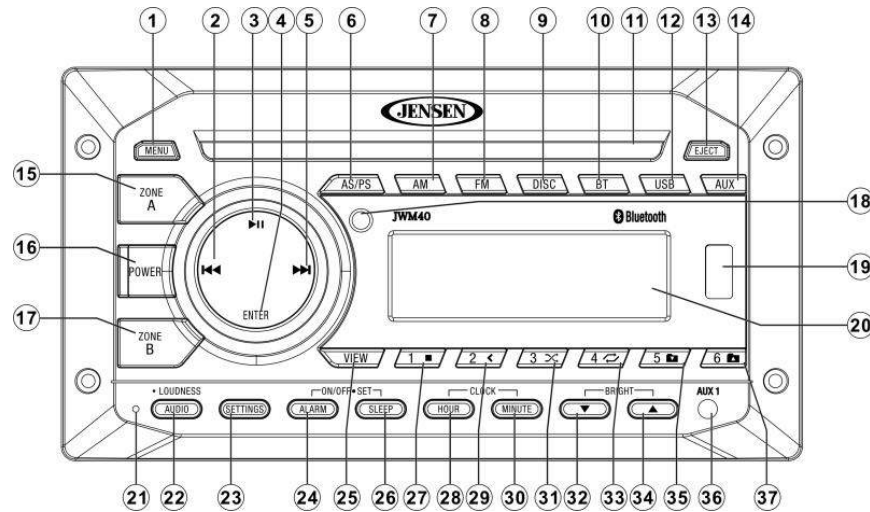

Automatically Store / Preset Scan (AS/PS)

Automatically Store

Select an AM or FM band. *Press and hold* the **AS/PS** button (6) for more than 3 seconds and the unit will automatically scan for and store 12 or 18 strongest station for all bands. To stop this function before the automatic storing is complete, press **AS/PS** again.

Preset Scan

Select a band. Press **AS/PS** button to scan stations stored in the current band. The unit will pause for 10 seconds at each preset station. Press **AS/PS** again to stop scanning when the desired station is reached.

Select a Band

1. Press **AM** button (7) repeatedly to select the band (AM1, AM2)
2. Press **FM** button (8) repeatedly to select the band (FM1, FM2 and FM3) Manual Tuning

Manual Tuning

Press the **>>|** or **|<<** buttons (5, 2) to seek stations up/down step by step.

Auto Seek Tuning

Press and hold the **>>|** or **|<<** buttons (5, 2) to automatically seek the next or previous strong station.

Preset Stations

Six numbered preset buttons store and recall stations for each AM and FM band.

Store a Station

Select a band (if needed). Press a 1-6 preset button to select the corresponding stored station.

DISC OPERATION

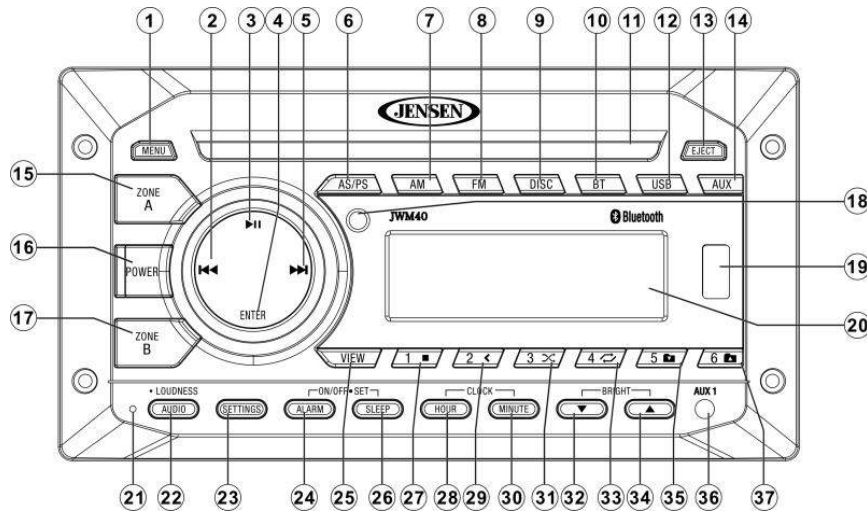

CD OPERATION

Inserting a CD

Insert a CD label-side up into the disc slot (11) and the disc will begin to play automatically.

Ejecting a CD

Press the **EJECT** button (13) to stop CD play and eject the CD.

Pausing Playback

Press the **▶||** button (3) to suspend or resume disc play

Stop Playback

Press the **1■** button (27) to suspend disc play, and "PRE-STOP" will appear on the display. Press the **▶||** button to resume disc playback from the last position. Press **1■** button twice and "STOP" will appear on the display.

Track Select

Press the **>>|** or **|<<<** buttons (5, 2) to advance to the previous or next track on the CD. The selected track number will appear on the display. *Press and hold* the **>>|** or **|<<<** buttons for more than three seconds to fast forward or fast reverse through the disc. CD play starts when the play/pause button is pressed.

Fast Forward/Reverse

Press and hold the **>>|** or **|<<<** buttons or press the **>>** or **<<** buttons on the remote control (16) once for FAST FORWARD/REVERSE X 2. *Press and hold* additional times for FAST FORWARD/REVERSE X 4, X 8, X 20 or PLAY. Press the **▶||** button on the control panel (3) or remote control (17) to end fast forward or reverse and resume normal playback.

Repeat (RPT)

Press the **4↻** button (33) during disc play to access the repeat function. Press again to continuously repeat the selected track (RPT ONE). Press a third time to repeat all tracks (RPT ALL). Press one more time to stop the repeat function (RPT OFF).

Random Shuffle (RDM)

Press the **3∞** button (31) during disc play to play all tracks on CD in random, shuffled order (RDM ON). Press **3∞** again to stop random play (RDM OFF).

Remote Control Direct Track Entry

To select a track directly, use the number pad on the remote control (9). For single digit entries, press the corresponding number for two digit entries. Press the **10+** button followed by the last digit (i.e., for track 16, press **10+** and then 6).

GOTO Direct Track/Chapter Access

Use the **GOTO** function to access a track (chapter) directly.

1. Press the **GOTO** button (25) on the remote control. The On Screen Display information will appear with the track number highlighted.
2. Use the number keys on the remote control to enter the 3-digit track number directly (i.e. for track 10, enter "010").
3. Press the **ENTER** button (5) to confirm and begin playback.

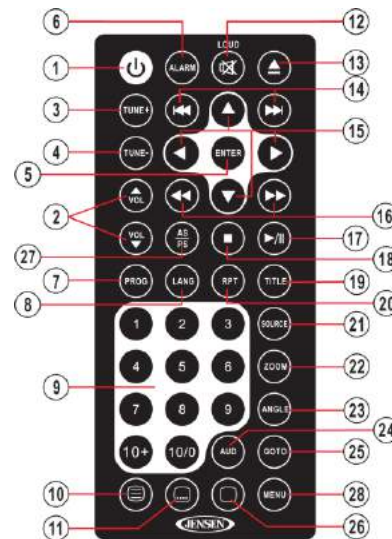

CD Playback Information

The following information is displayed on the screen during CD playback:

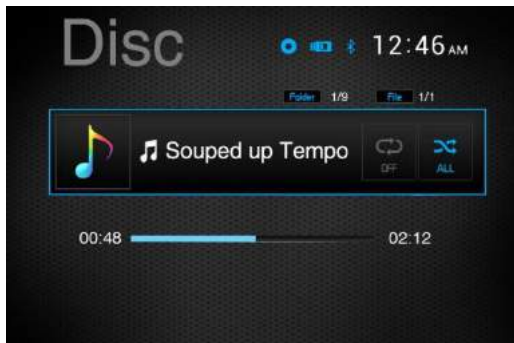

Folder 1/9 –The first number (1) indicates the current folder that is currently playing. The second number (9) indicates the number of available folders.

File 1/1 - The first number (1) indicates the current file that is currently playing. The second number (1) indicates the number of available files.



Press the **4**  button (33) during disc play to access the repeat function.



Press the **3**  button (31) during disc play to play all tracks on CD in random, shuffled order (RDM ON)



00:48 – remaining playing time of current track;

02:12 – total playing time of current track.

DVD OPERATION

DVD Title Menu

Press the **MENU** button (1) to go to the DVD title menu while in DVD mode.

Inserting a Disc

Insert a disc label-side up into the disc slot (11) and the disc will begin to play.

NOTE: Press the **DISC** or **USB** button (9, 12) to alternate between the **USB** and **DVD** source.

Ejecting a DVD

Press the **EJECT** button (13) to stop DVD play and eject the DVD

Pausing Playback

Press the **▶||** button (3) to suspend or resume disc play

Stop Playback

Press the **1■** button (27) to suspend disc play, and “PRE STOP” will appear on the display. Press the **▶||** button (3) to resume disc play from the last position. Press **1■** button twice and “STOP” will appear on the display.

Track Select

Press the **>>|** or **|<<** buttons (5, 2) to advance to the next or previous track on the disc. The selected track number will appear on the display

Enter/Select

While in menu mode, press the **ENTER** button (4) to select a menu option.

Language Selection

While playing a DVD, press the **6/FOLDER UP** button (37) to change the DVD audio language.

Fast Forward/Reverse

Press and hold the **>>|** or **|<<** buttons (5, 2) or press the **>>** or **<<** buttons on the remote control (16) once for FAST FORWARD/REVERSE X 2. Press and hold additional times for FAST FORWARD/REVERSE X 4, X 8, X 20 or PLAY. Press the **▶||** button on the control panel (3) or remote control (17) to end fast forward or reverse and resume normal playback

Repeat Chapter/Title

Press the **4**  button (33) on the control panel or the **RPT** button (20) on the remote control multiple times during playback to select from the following repeat play options:

- DVD: RER Chapter, RER Title, RPT All, RPT OFF

DVD Playback Features

The following remote control features, along with many others, are available during DVD playback (see “Remote Control Operation” on page 16 for complete functionality):

- **LANG:** Press to choose an alternate audio language, if available,
- **SUBTITLE:** Press to select an alternate subtitle language, if available,
- **ANGLE:** Press to select an alternate viewing angle, if available.
- **ZOOM:** Press to zoom the picture at ZOOM 2, ZOOM 3, ZOOM 4, ZOOM 1/2,

ZOOM 1/3 or ZOOM 1/4, or select OFF to return to normal view.

NOTE: Feature availability is dependent upon DVD embedded information.

Playback Information

During DVD and VCD playback, press the  button (26) on the remote control to display playback information on the screen, including the media playing and current playback time.

Continue pressing the  button additional times to display additional information, as indicated below.

DVD Playback Information

The following information is displayed at the top of the screen during DVD playback:

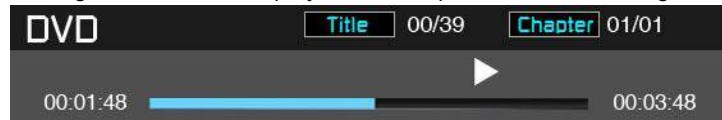

Title 00/39 – The first number (00) indicates the current title that is currently playing. The second number (39) indicates the number of available titles.

Chapter 01/01 –The first number (01) indicates the current chapter that is currently playing. The second number (01) indicates the number of available chapters.

Remote Control Direct Track Entry

To select a track directly, use the number pad on the remote control (9). For single digit entries, press the corresponding number. For two digit entries, press the **10+** button followed by the last digit (i.e., for track 16, press **10+** and then **6**).

GOTO Direct Track/Chapter Access

Use the GOTO function to access a track (chapter) directly.

1. Press the **GOTO** button (25) on the remote control. The On Screen Display information will appear with the track number highlighted.
2. Use the number keys on the remote control to enter the 3-digit track number directly (i.e. for track 10, enter "010").
3. Press the **ENTER** button to confirm and begin playback.

MP3/USB OPERATION

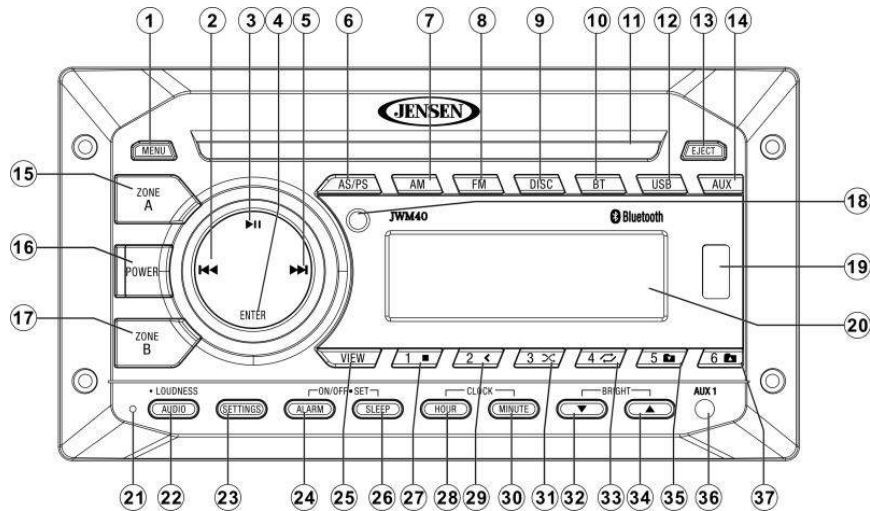

If the user connects a USB mass storage device, the radio automatically powers on, if necessary, and switches to digital file playback mode and selects that physical media. Changing modes or turning off the radio pauses playback. Playback will resume exactly where paused when returning to digital file playback mode.

Inserting a USB Device

The **USB connector** (19) is at the right side of the panel. Insert a USB device to automatically access USB mode and begin playback. The LCD will display "LOADING" and "USB" while files are initially loaded. When USB is removed, it will automatically back to the previous mode before the USB is connected. During other playback mode, when USB is connected, press **USB** (12) to enter USB playback mode directly.

NOTE: MP4 video format is not supported.

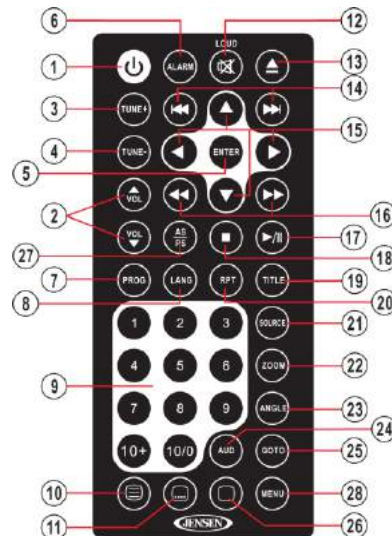

NOTE: Smart phone playback is not supported through USB, it must be done over Bluetooth. 1A charging is supported with compatible devices.

MP3 Monitor Display

After loading an MP3 disc or USB device, the following screen will appear on your output monitor.



Select one of these icons to access the corresponding media on your disc or USB device. If the media type is not present, the icon will not be selectable.

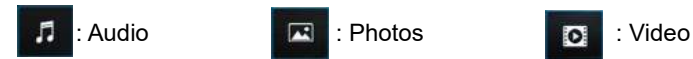

Play/Pause

Press the ►|| button (3) to suspend or resume disc play

Track Select

When playback is stopped, press the >>| or |<< button (5, 2) or |<< or >>| button on the remote control to search in the current folder. During playback, press the >>| or |<< button to access the previous/next file. The selected file number will appear on the display.



Folder Up/Down

Press and hold the **6/FOLDER UP** button (37) to access a higher folder level (FOLDER UP). Press and hold the **5/FOLDER DOWN** button (35) to access a lower folder level (FOLDER DN).

Repeat (RPT)

Press the **4** button (33) on the control panel or the **RPT** button (20) on the remote control multiple times during playback to select from the following repeat play options: RPT 1 (track), RPT DIR (folder), RPT ALL (disc), RPT OFF.

Random Shuffle (RDM)

Press the **3**  button (31) during song playback to play all files in random, shuffled order. Press **3**  again to stop random play.

Fast Forward/Reverse

Press and hold the **>>|** or **|<<<** buttons or press the **>>** or **<<** buttons on the remote control (16) once for FORWARD X 2. Press and hold additional times for FORWARD X 4, X 8, X 20 or PLAY. Press the **▶||** button on the control panel (3) or remote control (17) to end fast forward or reverse and resume normal playback

Remote Control Direct Track Entry

To select a file directly, use the number pad on the remote control (9). For single digit entries, press the corresponding number. For two digit entries, press the **10+** button followed by the last digit (i.e., for file 16, press **10+** and then **6**).

GOTO Direct Track/Chapter Access

Use the **GOTO** function to access a track (chapter) directly.

1. Press the **GOTO** button (25) on the remote control. The On Screen Display information will appear with the track number highlighted.
2. Use the number keys on the remote control to enter the 3-digit track number directly (i.e. for track 10, enter "010").
3. Press the **ENTER** button (5) to confirm and begin playback.

MP3 Playback Information

The following information is displayed at the top of the screen during MP3 playback:



Folder 1/9 –The first number (1) indicates the current folder that is currently playing. The second number (9) indicates the number of available folders.

File 1/1 - The first number (1) indicates the current file that is currently playing. The second number (1) indicates the number of available files.



Press the **4**  button (33) during disc play to access the repeat function.



Press the **3**  button (31) during disc play to play all tracks on CD in random, shuffled order (RDM ON)

00:48



02:12

00:48 – remaining playing time of current track;

02:12 – total playing time of current track.

BLUETOOTH OPERATION

The JWM40 includes built-in Bluetooth technology that allows you to connect this head unit to Bluetooth-enabled devices for streaming audio playback.

About Bluetooth Technology

Bluetooth wireless technology is a short-range wireless radio protocol. Operating in the 2.4 GHz range, it transmits audio and data at speeds up to 2.1 Mbit/s over a range of up to 10 meters.

Bluetooth Menu Options

NOTE: Please note that some Bluetooth menu options are only available while the unit is in Bluetooth Audio mode.

Press and hold the **BT** button (10) to enter menu adjustment mode. Repeatedly press the **>>|** or **|<<** buttons (5, 2) or **SETTINGS** button (23) to access the "Bluetooth On/Off" menu function. Rotate the volume encoder knob to select **BLUETOOTH ON**, then press the **ENTER** button (12) to turn the Bluetooth function On or Off. The following menu options are available when the unit is in Bluetooth mode.

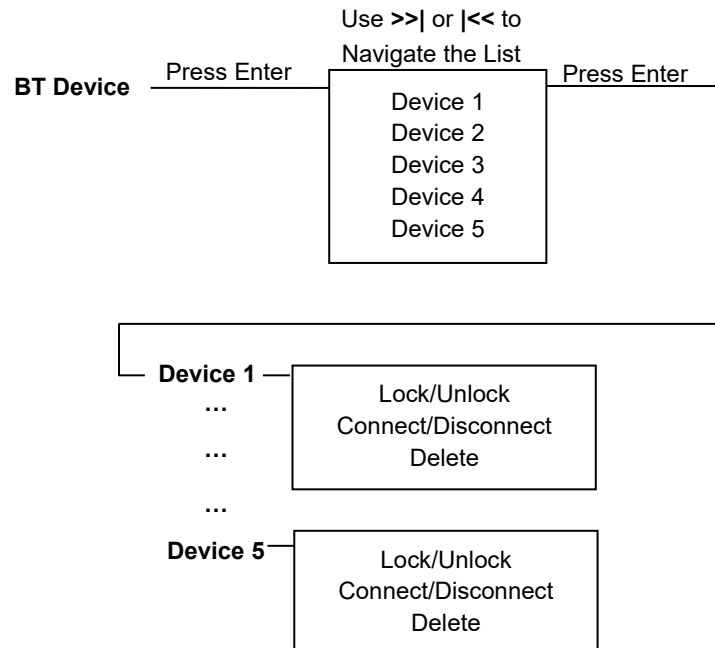

- **Bluetooth Pair <ENTER>:** Press and hold **BT** button (10) to start pairing with a Bluetooth enabled device.
- **Bluetooth Device:** Press the **ENTER** knob button to view a list of previously paired mobile devices models. Press the **>>|** or **|<<** buttons to view devices from the list. You cannot delete a device that is actively connected. Press the **ENTER** knob button to select the device. Press the **>>|** or **|<<** button to choose Lock/Unlock, Connect/Disconnect or Delete for this device.
- **Bluetooth Pair (BT Pair):** Press and hold the **BT** button for about 4 seconds to start pairing with a Bluetooth
- **Disconnect:** To disconnect a paired device, press the **ENTER** knob button to temporarily remove the Bluetooth link. The link can be re-established through your phone menu by selecting the JWM40 for connection.
- **Lock/Unlock:** The JWM40 can store up to 5 devices for Bluetooth connection. The devices are stored in FIFO (First In First Out) order. To prevent a device from being bumped from the list when more than 5 devices are used, you must lock the device. To Lock/Unlock a device, press the **ENTER** knob button.
- **Delete:** To delete a device from the list, press the **ENTER** knob button.

Pairing a Bluetooth Device

Before you begin, consult the owner's manual for the Bluetooth device you want to pair with the JWM40.

1. Press the **BT** button (10) to enter Bluetooth mode.
2. Press and hold the **BT** button to start the Bluetooth pairing process. The JWM40 will display "PAIR" and will be available to pair for 120 seconds.
3. In your device Bluetooth settings, select "JWM40" to connect.
4. If prompted for a password, enter "0000".

After connecting successfully, you will be able to listen to audio from your Bluetooth enabled device through the JWM40.

Bluetooth Audio (A2DP)

The A2DP music is available for Bluetooth enabled phones when the phone is connected. To access Bluetooth mode and play songs stored in your phone, press the **BT** button (10) to enter the Bluetooth mode.

While in Bluetooth mode, the "BT PAUSE" will display on the LCD.

Selecting Tracks

During playback, press the **>>|** or **|<<** button (5, 2) to play the previous or next track.

Pausing Playback

During playback, press the ►|| button (3) to pause the Bluetooth audio playback. “BT PAUSE” will appear on the LCD. Press ►|| button again to resume playback.

If you change to another mode, the mobile device audio will pause. Press the **BT** button (10) to return to Bluetooth mode and resume mobile phone audio playback.

NOTE: If a Bluetooth device is disconnected due to the power being turned off or if the device is out of range, the unit will automatically search for the matching Bluetooth mobile device when the power is restored.

REMOTE CONTROL OPERATION

| REF | DESCRIPTION | TUNER | BLUETOOTH | CD/MP3/USB | DVD |
|-----|-----------------------|--|--|---|---|
| 1 | Power | Turn radio on/standby mode. | Turn radio on/standby mode. | Turn radio on/standby mode. | Turn radio on/standby mode. |
| 2 | VOL +/- | Adjust volume up/down. Press for Audio Control Setup menu. | Adjust volume up/down. Press for Audio Control Setup menu. | Adjust volume up/down. Press for Audio Control Setup menu. | Adjust volume up/down. Press for Audio Control Setup menu. |
| 3 | TUNE + | Tune to higher station. | | | |
| 4 | TUNE - | Tune to lower station. | | | |
| 5 | ENTER | | | Confirm menu selection. | Confirm menu selection. |
| 6 | ALARM | Turn the alarm feature on/off. | Turn the alarm feature on/off. | Turn the alarm feature on/off. | Turn the alarm feature on/off. |
| 7 | LANG | | | | Select alternate audio language, if available. |
| 8 | Numeric Keyboard | Use 1-6 to access preset stations. | | Enter track number to access track directly. For track Number > 10, use 10+ followed by second digit. | Enter track number to access track directly. For track Number > 10, use 10+ followed by second digit. |
| 9 | Setup | | | View SETUP menu. | View SETUP menu. |
| 10 | Subtitle | | | | Choose subtitle language, if available. |
| 11 | Mute/LOUD | Silence Audio output. <i>Press and hold</i> to turn LOUDNESS feature on/off. | Silence Audio output. <i>Press and hold</i> to turn LOUDNESS feature on/off. | Silence Audio output. <i>Press and hold</i> to turn LOUDNESS feature on/off. | Silence Audio output. <i>Press and hold</i> to turn LOUDNESS feature on/off. |
| 12 | Eject | Eject Disc. | Eject Disc. | Eject Disc. | Eject Disc. |
| 13 | Previous/Next | | Select next/previous track. | Select next/previous track. | Select next/previous chapter. |
| 14 | Directional Buttons | | | Move to desired menu item and then press ENTER to confirm. | Use with DVD menu to move to desired menu item and then press ENTER to confirm. |
| 15 | Fast Reverse/ Forward | | | Fast Forward 2X, 4X, 8X, 20X. Fast Reverse 2X, 4X, 8X, 20X. | Fast Forward 2X, 4X, 8X, 20X. Fast Reverse 2X, 4X, 8X, 20X. |
| 16 | Play/Pause | | Pause/resume playback. | Pause/resume playback. | Pause/resume playback. |
| 17 | Stop | | | Stop playback. | Stop playback. |
| 18 | TITLE | | | | Press to view title menu. Use directional arrows and play button to play selected title. May not be supported by all discs. |
| 19 | RPT | | | Repeat track. | Repeat chapter. |
| 20 | SOURCE | Select source for playback. | Select source for playback. | Select source for playback. | Select source for playback. |

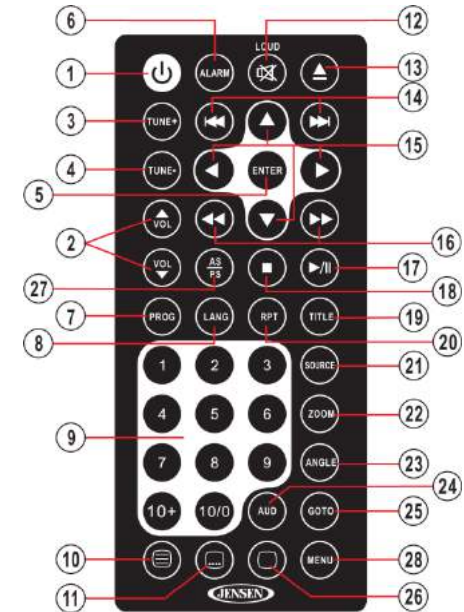

| | | | | | |
|----|---------|--|----------------------------|---|--|
| 21 | ZOOM | | | | Zoom picture or press repeatedly to change magnification level. |
| 22 | ANGLE | | | | Select alternate viewing angle, if available. |
| 23 | AUD | Access Audio Menu options. | Access Audio Menu options. | Access Audio Menu options. | Access Audio Menu options. |
| 24 | GOTO | | | Select exact time, track or chapter for playback. | Select exact time, track or chapter for playback. |
| 25 | Display | | | Display current playback information on the screen. | Display current playback information on the screen. |
| 26 | AS/PS | Browse preset stations (10 sec. interval). <i>Press and hold</i> to scan/store stations. | | | |
| 27 | MENU | Access system MENU. | Access system MENU. | Access system MENU. | Press to access system MENU. <i>Press and hold</i> to access DVD MENU. |

DVD SETTINGS

Press the  (setup) button (10) on the remote control to access the Settings menu and adjust system settings for the following categories:



- Audio Language: English, Chinese, Japanese, French, Spanish, Portuguese, Latin or German
- Subtitle Language: On/ Off
- Menu Language: English, Chinese, Japanese, French, Spanish, Portuguese, Latin or German
- Password: 4 digit password
- Rating: Select the parental control level for all DVD plays: Kid Safe > Adult. The security password is required to make changes to this feature.
- Aspect Ratio: 4:3 PS, 4:3 LB, 16:9

CARE AND MAINTENANCE

- Keep the product dry. If it does get wet, wipe it dry immediately. Liquids might contain minerals that can corrode the electronic circuits.
- Keep the product away from dust and dirt, which can cause premature wear of parts.
- Handle the product gently and carefully. Dropping it can damage circuit boards and cases, and can cause the product to work improperly.
- Wipe the product with a dampened cloth occasionally to keep it looking new. Do not use harsh chemicals, cleaning solvents, or strong detergents to clean the product.
- Use and store the product only in normal temperature environments. High temperature can shorten the life of electronic devices, damage batteries, and distort or melt plastic parts.

Ignition

The most common source of noise in reception is the ignition system. This is a result of the radio being placed close to the ignition system (engine). This type of noise can be easily detected because it will vary in intensity of pitch with the speed of the engine.

Usually, the ignition noise can be suppressed considerably by using a radio suppression type high voltage ignition wire and suppressor resistor in the ignition system. (Most vessels employ this wire and resistor but it may be necessary to check them for correct operation.) Another method of suppression is the use of additional noise suppressors. These can be obtained from most CB/A radio or electronic supply shops.

Interference

Radio reception in a moving environment is very different from reception in a stationary environment (home). It is very important to understand the difference. AM reception will deteriorate when passing under a bridge or when passing under high voltage lines. Although AM is subject to environmental noise, it has the ability to receive at great distance. This is because broadcasting signals follow the curvature of the earth and are reflected back by the upper atmosphere.

TROUBLESHOOTING

| Symptom | Solution |
|--|--|
| Radio will not turn ON or No front panel operation | Try the reset button. |
| | Check fuse. |
| | Check 12V+ on accessory wire to radio (RED wire) |
| | Check Ground. |
| Radio turns ON, but no sound | Verify Volume, Fader/Balance, Mute controls are set correctly (see owner's manual). |
| | Try the reset button. |
| | Verify proper speaker selection. |
| | Verify proper speaker connections. |
| | Check for shorts or open circuits on speaker wires. <ul style="list-style-type: none"> • If short on "A" channel, "B" channels will continue to function. • If short on "B" channels, "A" channel will continue to function. |
| CD/DVD does not load fully | Make sure unit has power and no other CD/DVD is currently inside. |
| | Make sure transport screw has been removed from rear of unit. Disc will load for several seconds and then eject if transport screw has not been removed. |
| CD/DVD does not play correctly | Check to make sure disc is inserted correctly. |
| | Verify disc is free from dirt, scratches, etc. |
| | Check with factory CDs. |
| | Inspect radio's chassis to verify shipping screw(s) have been removed. |
| No AM or FM reception | Check factory original CDs for compatibility warnings (due to various copy-protection, multimedia content, etc.). |
| | Verify you are tuned to a valid station. |
| | Check your antenna connection on rear of stereo. |
| DVD plays sound but no video | Try a different antenna |
| | Make sure the HDMI cable is routed from the HDMI output to the input on the television. |
| Unit does not respond to Remote Control | Verify that you have a clear line of sight for the IR signal. |
| | Check the batteries. |
| | Confirm the remote IR sensor is plugged into IR input (if applicable). |

SPECIFICATIONS

FM Tuner

| | |
|------------------------------------|-------------------|
| Frequency Coverage (USA) | 87.5 to 107.9 MHz |
| Sensitivity | <4 μ V |
| Stereo Separation@1 kHz | >25 dB |

AM Tuner

| | |
|----------------------------------|--------------|
| Frequency Range (USA) | 530-1710 kHz |
| Sensitivity (S/N=20dB) | <63 μ V |

Amplifier

| | |
|----------------------------|--|
| Output Power | 6W RMS x 4 |
| Output Impedance | Compatible with 4-8 Ω ohms speakers, 4 ohm load minimum |

DVD

| | |
|------------------------------|--------------|
| Frequency Response | 20-20,000 Hz |
| Channel Separation | 50 dB |
| S/N Ratio | 65 dB |
| Distortion | 0.5% |

General

| | |
|-------------------------------------|---------------------------------------|
| Power Supply Requirements | DC 12 Volts, Negative Ground |
| Operating Voltage | 11-16 VDC |
| Overall Dimensions | 208mm (W) x 110.0mm (D) x 130.0mm (H) |
| | 8.19" (W) x 4.33" (D) x 3.39" (H) |
| Mounting Dimensions | 180mm (W) x 133mm (D) x 86mm (H) |
| | 7.09" (W) x 5.2" (D) x 3.39" (H) |
| Weight | 1.45 KG |
| | 3.20 lbs. |

FCC Notes

WARNING! Changes or modifications to this unit not expressly approved by the party responsible for compliance could void the user's authority to operate the equipment.

NOTE: This equipment has been tested and found to comply with the limits for a Class B digital device, pursuant to Part 15 of the FCC Rules. These limits are designed to provide reasonable protection against harmful interference in a residential installation.

This equipment generates, uses and can radiate radio frequency energy and, if not installed and used in accordance with the instructions, may cause harmful interference to radio communications.

However, there is no guarantee that interference will not occur in a particular installation. If this equipment does cause harmful interference to radio or television reception, which can be determined by turning the equipment off and on, the user is encouraged to try to correct the interference by one or more of the following measures:

- Reorient or relocate the receiving antenna.
- Increase the separation between the equipment and receiver.
- Connect the equipment into an outlet on a circuit different from that to which the receiver is connected.
- Consult the dealer or an experienced radio/TV technician for help.

This equipment complied with FCC radiation exposure limits set forth for an uncontrolled environment. This equipment should be installed and operated with minimum distance 20cm between the radiator & your body.

NOTE: The manufacturer is not responsible for any radio or TV interference caused by unauthorized modifications to this equipment. Such modifications could void the user's authority to operate the equipment.



ASA Electronics Corporation

www.asaelectronics.com

www.jensenheavyduty.com

©2018 ASA Electronics Corporation

v.100718